



KISTLER

measure. analyze. innovate.

Accelerometers

Providing quick,
accurate and
reliable motion data



Kistler has a great deal to offer

This catalog provides comprehensive information on all Kistler products for the measurement of acceleration.

The overview of the Kistler range is followed by detailed information on our products in tabular form and a presentation of the company as a whole.

Detailed catalogs are also available on the full range of Kistler products for the measurement of force and pressure.

As Kistler measuring instruments are used in a great variety of fields, separate brochures are also available for the following applications:

- Engines
- Vehicles
- Manufacturing
- Plastics Processing
- Biomechanics

The aim of this series of brochures is to help you make the right choice from our wide range of products and to suggest ways of optimizing their application.

Please contact us for any brochures you require. You will find the address of your nearest Kistler branch on the back page of the catalog. Alternatively, you can email us at info@kistler.com

We wish you every success with Kistler measurement instruments and thank you for your confidence and interest.



Contents

Kistler Measures Acceleration	4	Product Information	
Design and Use of Piezoelectric Accelerometers	6	Product Overview	15
Capacitive Accelerometers	8	Acceleration	22 
Acceleration Measuring Systems	10	Vibration	26 
Accelerometer Mounting	11	Acoustic Emission	42 
Product Information	14–80	Triaxial	44 
Piezoelectric Theory	82	Impulse	54 
Capacitive Accelerometer Theory	88	Electronics & Software	60 
Glossary	90	Accessories	68 
Kistler – Customer Service	92	Calibration	78 
The Kistler Spectrum	94		
Kistler Applications	96		
Kistler in Brief	98		
Technical Literature	100		

Kistler Measures Acceleration

Accelerometers are used in every avenue of the dynamic test environment and Kistler has developed families of products covering this expansive range of applications. From ultra low motions encountered in wafer fabrication technology to shock spectra reconstruction experienced in pyrotechnic separation event studies, and everywhere between, an optimal sensor solution is available. Static events are captured with the K-Beam static and low frequency product offerings. Very high frequency activity is routinely measured using any of several miniature piezoelectric single axis or triaxial types. Many sensing technologies including piezoceramic, natural quartz and variable capacitance approaches have been extensively explored and are employed as needed to accommodate the demands of the applications.

Some applications include:

Structural Testing

Mechanical devices, assemblies, and constructions of all types are investigated using accelerometers to measure their dynamic response when subjected to a known input. The deformation pattern, when the specimen experiences resonance, can be computed from the measured data.

Known as Experimental Modal Analysis (EMA), this field of study often uses a member of the PiezoBeam family or Ceramic Shear family where their general characteristics have been adapted to accommodate most requirements of common tests. Typical highlight features include high output from a low weight sensor, ground isolation, and an inexpensive package providing an economical solution for large channel count applications.

Aerospace and Military

Very demanding applications are encountered in the military and aerospace industry where any error may present a life-threatening situation. This category also covers a tremendous range of applications and nearly all accelerometer product offerings have been used in these important investigations. Flutter testing, rocket launch pad dynamics, aircraft EMA, ammunition investigations, helicopter rotor reactions, etc. are a few of the common measurements performed.





Automotive/Transportation

Ride quality has been receiving tremendous attention in recent years. New vehicle designs are presenting less noise to the occupants and the subtle details of the intricacies of road/tyre interaction, bump & jar response, and the overall feel of the ride are important to even the common customer. The K-Beam family covers the low to mid frequency range of many investigations and the many piezoelectric offerings extend into the higher frequency areas of interest.

Remarkable lifetime under any condition.

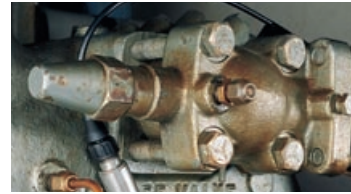

Precise, ultralow frequency, measurements are common using a K-Beam solution.



Civil Engineering

Very low frequency activity is of interest when studying extremely large structures such as bridges, buildings or dams. These specimens require DC capable accelerometers since most dynamic activity is in the very low frequency realm often in the range of a few hertz. The K-Beam product family is commonly used to measure vibration and acceleration in this arena.

Modal studies easily accomplished using an array of inexpensive accelerometers.



Tilt and comfort controlled using K-Beam feedback.



Environmental Stress Screening

Computer components, automotive electronics, and miniature mechanical assemblies are often exposed to an aggressive life test or actual functional tests under extreme environmental conditions. This may involve multiple impact drop testing or wide range thermal cycling and many of the K-Shear product offerings have been tailored to survive and perform extremely well even under incredibly abusive conditions. The -M5 and -M8 suffixes provide extreme high and low temperature capabilities respectively and the Shear Shock type 8742 and 8743 survive after many exposures to high-level cyclic inputs.

Space quality measurements are routine.



Flight safety issues measured accurately with K-Beam family.



Harsh environments present negligible concern when using K-Shear accelerometers.



On site or factory calibration solutions available.



Design and Use of Piezoelectric Accelerometers

Measuring acceleration

Piezoelectric accelerometers consist essentially of three basic elements: the sensor body, the piezoelectric sensing element and the seismic mass. Initially piezoelectric accelerometers incorporated a compression design whereby the compression cut, quartz crystal sensing element is preloaded between the base plate and seismic mass. Because of the constant seismic mass, the force acting on the measuring element is proportional to the acceleration in accordance with Newton's first law: $F = ma$. An electrical charge is generated proportional to the force (and hence the acceleration). Because they are basically AC coupled devices, piezoelectric accelerometers are not suitable for measuring constant (DC) accelerations like those generated in a centrifuge. For "true" DC acceleration measurement, refer to Kistler K-Beam accelerometers with variable capacitance sensing elements.

Although the compression cut quartz design was widely accepted with its inherent characteristics of long term stability, low mass, high rigidity and subsequent high resonant frequency, Kistler has focused on accelerometers which utilize a shear mode quartz element that is sensitive to imposed shearing forces and unaffected by other orthogonal force components. In addition, the primary charge sensitivity of shear mode quartz is twice that for compression mode quartz. This results in a smaller seismic system design in shear mode units and thereby reduces their overall size and mass. As in the compression design, the force acting on the element is proportional to the acceleration in accordance with Newton's first law: $F = ma$ and an electrical charge is generated proportional to the acceleration.



Kistler incorporates several other design features into their K-Shear units which provide combined features uncommon and superior to conventional compression designs.

Conventional compression type accelerometers can be designed to be insensitive to stresses resulting from imposed base strain simply by making the base extremely large.

The advantages of the shear design are realized by efficiently packaging the seismic system in a manner which isolates it from mechanically induced stresses such as base or case strain. With the K-Shear construction the imposed base/case strain is isolated from the quartz and is essentially negligible at the root of the seismic support.

Output resulting from thermally induced stress is also negligible in K-Shear accelerometers. On compression type accelerometers, stresses caused by expansion or contraction of internal elements act directly on the preload mechanism which results in a charge output from the quartz. Similar expansion or contraction of the preload screw in K-Shear accelerometers results in stresses which act in an insensitive crystal direction. The optimized K-Shear design further reduces thermal effects by producing a nearly uniform, self-cancelling thermal stress.

Piezotron and Picotron accelerometers are low impedance types which incorporate a miniature, built-in impedance converter for the charge-to-voltage conversion. Picotron units are distinguished from Piezotron by virtue of their very small (pico) size. Ceramic Shear is a new family of accelerometers designed for OEM and multichannel applications (i.e. modal analysis). They feature high output, low noise and extended temperature range in a low or high impedance package. PiezoBeam accelerometers incorporate a bimorph ceramic sensing element and a miniaturized, hybrid charge amplifier for the charge-to-voltage conversion. These units feature very high output (up to 1000 mV/g) in a very small (down to 5 grams), rugged package. For use in thermally stable environments.

In addition to incorporating either compressive or K-Shear designs, most Kistler piezoelectric accelerometers utilize built-in charge-to-voltage converters for low impedance, voltage output. The low end frequency response is usually limited to 0.5 Hz, which is adequate for most shock and vibration applications. Low impedance output also allows the usage of general purpose sensor cable in environments where moisture or contamination would be detrimental to the high insulation resistance for high impedance accelerometers. The low impedance design also provides immunity to RF/EMI.

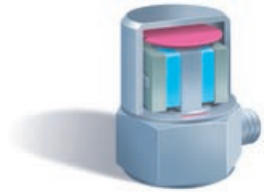

K-Shear®

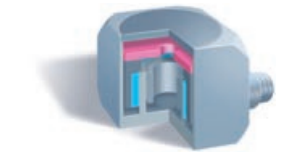

Annular Shear

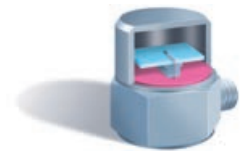

PiezoBeam®

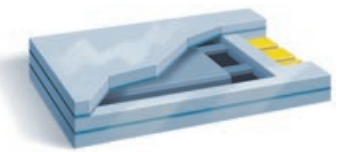

K-Beam®

Capacitive Accelerometers

Design and use of Variable Capacitance Accelerometers

Measurement of low frequency events including static or DC capability is accomplished using various designs based on the "variable capacitance" sensor principle. In a typical design, a diaphragm centered between two electrodes forms the seismic mass of the spring mass systems. The gap between each electrode and the central mass creates a repeatable electrical capacitance. When the mass is forced off center by an imposed acceleration, a differential capacitance exists between the two initially equal 'capacitors'.

This differential capacitance is linearly proportional to the applied acceleration within the specified amplitude range of the accelerometer. An electrical 'bridge' type circuit is used to achieve an appropriate voltage output. Using a differential approach creates immunity or common mode rejection to environmental influences since both 'capacitors' react similarly and the difference is usually negligible.

MEMS (Micro Electro Mechanical Sensor) technology is used in several designs since it offers very low seismic weight and a relatively stiff silicon supporting structure. The bulk micro-

machining processes now produce very high accuracy and repeatable elements that are required for high precision sensor designs. Advanced designs include a servo or feedback loop to restore the central mass to its origin by presenting an electrostatic restoring force to the appropriate electrode. Thus a 'null' type sensor is achieved yielding the best noise characteristics available in the industry. It's also entirely non-magnetic and therefore insensitive to magnetic fields.



Overload protection is incorporated in all designs with the surrounding electrodes limiting displacement of the seismic mass. Also, damping is achieved in some designs resulting from the compressed cavity gas reducing transient stresses. The relatively rugged construction compares well against competitive strain gauge type accelerometers. Power requirements are simple where often a single nine-volt battery connection is all that is required in addition to the output lead. The ease of installation combined with a robust, reliable sensor has guided these accelerometers into many applications formally outfitted with piezoresistive or expensive Servo type accelerometers.

Ride quality studies in many areas of transportation such as automobiles, trains, aircraft and marine vehicles have utilized the variable capacitance products where the frequencies of interest and ease of use made their selection obvious. The operation and refinement of wafer fabrication equipment has been extensively investigated using K-Beam accelerometers that are well adapted to measure the low level, low frequency events common to the processes. Dynamic studies on large structures require great accuracy at very low frequencies and again are an ideal fit to the variable capacitance product range.



Ground motion effects accurately recorded.



Smallest vibrations easily captured.



Acceleration Measuring Systems



Economical measurement solutions offered by the low impedance approach.



Versatile system configurations provided through charge amplifier functionality.

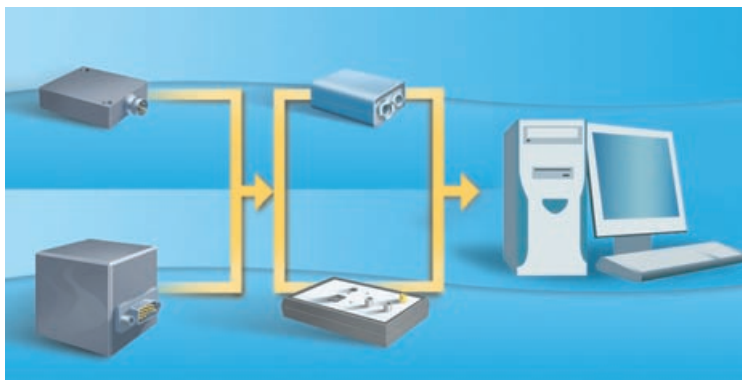

DC acceleration system easily configured.

Low impedance piezoelectric system (voltage mode)

Features

- Low output impedance, <100 ohms
- Low noise output signal
- Fixed accelerometer range and voltage sensitivity
- Simple two-wire system for power and signal with no special cable conductor requirements
- Lower cost per channel
- Simple and inexpensive signal conditioning; power supply/coupler and standard cables
- Coupler for setting of gain, range, filtering and time constant
- Frequency response from 0.5 to 20,000 Hz

High impedance piezoelectric system (charge mode)

Features

- Wide measuring range
- One accelerometer can be used over its entire measuring range by selecting an appropriate charge amplifier range
- Push-button, electronic or computer-controlled resetting of charge amplifier.
- Sensors having operational temperature range up to 250°C and above
- Charge amplifier for setting of range, filtering and time constant
- Frequency response from 0.5 to 20,000 Hz

Silicon micromachined variable capacitance system

Features

- True static and dynamic measuring response
- Frequency response from 0 to 300 Hz
- Both acceleration and inclination information possible using AC or DC coupled output
- Output signals can be either single-ended, bi-polar, differential voltages or current

See Piezoelectric Accelerometer Theory on pages 82 to 87 for further information.

Accelerometer Mounting

For an accelerometer to accurately sense and generate useful data, it must be properly coupled to the test object. This requires that the accelerometer mounting be rigid over the frequency range of interest. The methods for mounting an accelerometer usually depend on the accelerometer and the test structure. A selection of studs, isolated mounting pads, wax, magnets, and triaxial cubes are available from Kistler to solve virtually any mounting/installation problem. Some accelerometers have an electrically isolated mounting surface which provides electrical (ground) isolation between the sensor signal ground and the mounting surface.

Stud mounting

The best method for mounting an accelerometer is with a threaded stud. Most Kistler mounting studs are machined from Beryllium Copper for high strength and low modulus of elasticity, coupled with high elastic limits. These studs provide excellent coupling between the accelerometer's mounting surface and the test object.

Care should be taken to ensure that the two mounting surfaces mate evenly. The mounting threads must be perpendicular to the surface and free of any burrs. The surface must also be flat to ensure good coupling. Adding a slight amount of grease or oil between the mounting surfaces improves the coupling, especially at higher frequencies.

A designated mounting torque provides the proper coupling force between the accelerometer and the test object without overstressing and distorting the accelerometer mounting base. Always use the proper sockets and torque for each Kistler accelerometer as listed on the individually supplied calibration certificates.

Adhesive mounting

This simple method is ideal for mounting where drilling holes is not practical or where the mounting surface is not flat.

Direct Adhesive Mounting

Many lightweight accelerometers are designed strictly for adhesive mounting. When properly mounted, these units will provide accurate data within the specified frequency range. This method is ideal for modal and structural analysis where the test structure cannot be modified for mounting the accelerometers. For measurements up to 5 kHz, wax mounting is a suitable adhesive.

Isolated, Adhesive Pad Mounting

Hard anodized aluminium mounting pads offer several advantages when the accelerometer must be mounted to irregular surfaces or when ground isolation is required. These pads are adhesively mounted to the test structure providing a flat mounting surface and a high quality mounting thread. The hard anodized surface provides ground isolation between the sensor and the mounting surface. This is particularly useful in preventing ground loops.

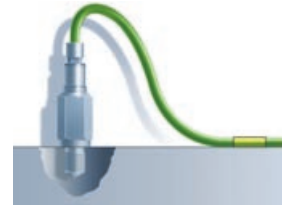

Top-mounted connector.

Tape or clamp to relieve stress on connector

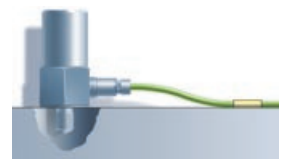

Side-mounted connector.

Tape or clamp to relieve stress on connector (about 2½ to 3 inches from connector)

Accelerometer Mounting

Magnetic mounting

For special applications where the accelerometer needs to be mounted to ferromagnetic structures for a quick test, one of several Kistler magnetic mounts can be used.

The accelerometer is first mounted to the magnet. These mounts can then be moved quickly to measure vibrations at several different locations. Due to the higher mass, magnets are only recommended for measurements of vibrations with frequencies up to 1000 Hz. Further, the added mass may affect the measurement of very light structures due to mass loading.

Triaxial mounting

Several triaxial mounting cubes are available from Kistler which allow mounting of up to three individual accelerometers in orthogonal directions. The cube's added mass and size must be considered and may affect the overall system frequency response. Kistler also offers integral triaxial units for those applications where mass and size profile are critical. The optimized integral package often provides the best measurement solution.

Strain relieving cables

Accelerometer cables should be taped or clamped to the same surface on which the accelerometer is attached to avoid motion between the vibration surface and the tie down point. These techniques will prevent flexing of the cable near the connector and thereby minimize any resultant frequency response errors.

Accelerometer mounting accessories

Refer to pages 69 to 71 for details on mounting accessories for Kistler accelerometers.

Kistler calibration

Kistler accelerometers are calibrated in the factory and delivered with a calibration certificate. The reference sensors are cross-referenced to national standards. Kistler operates a NIST traceable calibration center and the calibration laboratory No. 049 of the Swiss Calibration Service for the measurands: force, pressure, acceleration and electric charge. Kistler and some of its group companies offer a recalibration service and the company records in its archives the details of when and how often a particular sensor was calibrated.

Kistler offers an on-site service for recalibrating built-in sensors, thereby helping to keep downtimes to a minimum. In addition, Kistler offers a whole range of instruments for use in calibration laboratories.

Our calibration service receives the highest marks. The calibration of your instruments, manufactured by Kistler or someone else, is performed with the utmost care and precision. Our standard prompt service is exceptional. The Kistler Calibration Laboratory has been in conformance with the requirements of ANSI/NCSL Z540-1-1994, MIL-STD-45662A, ISO 9001:2000 and now is fully accredited to ISO/IEC 17025.

On site, traceable, calibration systems.

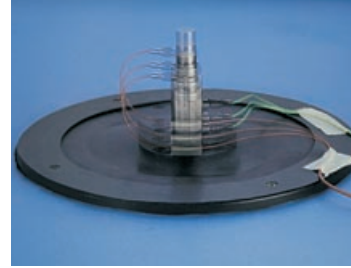

National referenced calibration services available.



Product Information

The selection process to identify the best accelerometer for a specific application is complicated and often difficult when detailed data sheets are reviewed independently. The following pages group the accelerometer product offerings by category and specification.

This valuable table should be used as a general guide to refine the selection options to a few choices where more specific detail is available on the page identified in the table. The data sheet containing all relevant information is readily available on the internet at www.kistler.com



Product Overview

Low Amplitude, Low Frequency (0 to 300 Hz) Measurements, Single Axis								Voltage Output	
Model	Range ±g	Sensitivity mV/g	Threshold g_{rms}	Frequency Response Hz (±5%)	Mass grams	Connector Location & Type	Mounting Method & Thread Size	Ground Isolation	Page #
8310A50	50	40	0,0057	0 ... 500	17	side, 4 pin	4-40 cap screw	yes	23
8310A50M11	50	40	0,0057	0 ... 500	17	side, integral cable to pigtails	4-40 cap screw	yes	23
8310A25A1	25	80	0,0029	0 ... 300	17	side, 4 pin	4-40 cap screw	yes	23
8310A25A1M11	25	80	0,0029	0 ... 300	17	side, integral cable to pigtails	4-40 cap screw	yes	23
8305A10M2	10	200	0,0014	0 ... 180	6,5	side, integral cable to pigtails	4-40 cap screw	yes	23
8310A10	10	200	0,0028	0 ... 180	17	side, 4 pin	4-40 cap screw	yes	23
8310A10M11	10	200	0,0028	0 ... 180	17	side, integral cable to pigtails	4-40 cap screw	yes	23
8312A10	10	200	0,0028	0 ... 180	12	side, 4 pin	4-40 cap screw	yes	25
8305A10	10	100	0,0014	0 ... 180	6,5	side, integral cable to pigtails	4-40 cap screw	yes	23
8305A10M4	10	100	0,0014	0 ... 180	6,5	side, integral cable to 4-pin pos.	4-40 cap screw	yes	23
8305A10M7	10	100	0,0014	0 ... 180	6,5	side, integral cable to 4-pin neg.	4-40 cap screw	yes	23
8330A2,5	2,5	1500	0,0000025	0 ... 200	28,5	side, 4 pin	4-40 cap screw	yes	25
8310A2	2	1000	0,00054	0 ... 300	17	side, 4 pin	4-40 cap screw	yes	23
8310A2M11	2	1000	0,00054	0 ... 300	17	side, integral cable to pigtails	4-40 cap screw	yes	23
8312A2	2	1000	0,00054	0 ... 300	12	side, 4 pin	4-40 cap screw	yes	25
8305A2M2	2	1000	0,00028	0 ... 250	6,5	side, integral cable to pigtails	4-40 cap screw	yes	23
8305A2	2	500	0,00028	0 ... 250	6,5	side, integral cable to pigtails	4-40 cap screw	yes	23
8305A2M4	2	500	0,00028	0 ... 250	6,5	side, integral cable to 4-pin pos.	4-40 cap screw	yes	23
8305A2M7	2	500	0,00028	0 ... 250	6,5	side, integral cable to 4-pin neg.	4-40 cap screw	yes	23

Product Overview

General Purpose Vibration Measurement, Single Axis							High Impedance Charge Mode		
Model	Range ±g	Sensitivity pC/g	Threshold g _{rms}	Frequency Response Hz (±5%)	Mass grams	Connector Location & Type	Mounting Method & Thread Size	Ground Isolation	Page #
8202A10	2 000	-10	0,03	5 ... 10 k	14,5	side, 10-32	10-32 stud	no	28
8203A50	1 000	-50	0,0006	5 ... 4 k	44,5	side, 10-32	10-32 stud	no	28
8274A5	2 000	-5.5	0,01	1 ... 10 k	4,0	top, 10-32	10-32 stud	no	29
8276A5	2 000	-5.5	0,01	1 ... 7 k	4,0	side, 10-32	adhesive	no	29

General Purpose Vibration Measurement, Single Axis							Low Impedance Voltage Mode		
Model	Range ±g	Sensitivity mV/g	Threshold g _{rms}	Frequency Response Hz (±5%)	Mass grams	Connector Location & Type	Mounting Method & Thread Size	Ground Isolation	Page #
8704B5000	5 000	1	0,13	1 ... 10 k	7,1	top, 10-32	10-32 stud	with pad*	33
8720A500	500	10	0,01	1 ... 9 k	4,9	side, 10-32	wax or adhesive	yes	35
8704B500	500	10	0,01	1 ... 10 k	8,6	top, 10-32	10-32 stud	with pad*	33
8704B500M1**	500	10	0,01	1 ... 10 k	9,6	top, 10-32	10-32 stud	yes	33
8702B500	500	10	0,01	1 ... 10 k	8,6	side, 10-32	10-32 stud	with pad*	33
8702B500M1**	500	10	0,01	1 ... 10 k	9,6	side, 10-32	10-32 stud	yes	33
8704B100	100	50	0,01	0,5 ... 10 k	8,6	top, 10-32	10-32 stud	with pad*	32
8704B100M1	100	50	0,01	0,5 ... 10 k	9,6	top, 10-32	10-32 stud	yes	32
8702B100	100	50	0,01	0,5 ... 10 k	8,6	side, 10-32	10-32 stud	with pad*	32
8702B100M1	100	50	0,01	0,5 ... 10 k	9,6	side, 10-32	10-32 stud	yes	32
8704B50	50	100	0,006	0,5 ... 10 k	8,6	top, 10-32	10-32 stud	with pad*	32
8704B50M1	50	100	0,006	0,5 ... 10 k	9,6	top, 10-32	10-32 stud	yes	32
8702B50	50	100	0,006	0,5 ... 10 k	8,6	side, 10-32	10-32 stud	with pad*	32
8702B50M1	50	100	0,006	0,5 ... 10 k	9,6	side, 10-32	10-32 stud	yes	32
8141	50	100	0,002	10 ... 6 k	30	integral to 10-32	M6 cap screw	yes	30
8774A50	50	100	0,0025	1 ... 10 k	4,0	top, 10-32	10-32 stud	with pad*	39
8776A50	50	100	0,0025	1 ... 7 k	4,3	side, 10-32	wax or adhesive	no	39
8776A50M1	50	100	0,0025	1 ... 7 k	4,3	side, 10-32	wax or adhesive	yes	39
8776A50M3	50	100	0,0025	0,5 ... 4 k	4,3	side, 10-32	wax or adhesive	yes	40
8776A50M6	50	100	0,0025	1 ... 10 k	4,5	side, 10-32	10-32 stud, integral	with pad*	39
8710A50M1	50	100	0,002	0,35 ... 7 k	43	side, 10-32	1/4-28 stud	yes	34
8752A50	50	100	0,002	0,5 ... 5 k	115	top MIL-C-5015	1/4-28 stud	yes	38
8704B25	25	200	0,003	1 ... 9 k	8,6	top, 10-32	10-32 stud	with pad*	32
8704B25M1	25	200	0,003	1 ... 9 k	9,6	top, 10-32	10-32 stud	yes	32
8702B25	25	200	0,003	1 ... 9 k	8,6	side, 10-32	10-32 stud	with pad*	32
8702B25M1	25	200	0,003	1 ... 9 k	9,6	side, 10-32	10-32 stud	yes	32
8784A5	5	1 000	0,0004	1 ... 6 k	21	top, 10-32	10-32 stud	with pad*	41
8786A5	5	1 000	0,0004	1 ... 6 k	21	side, 10-32	10-32 stud	with pad*	41
8712A5M1	5	1 000	0,0004	0,5 ... 8 k	51	side, 10-32	1/4-28 stud	yes	34

* Adhesive mounting pads made of aluminium with a hard anodized shell provide ground isolation, see datasheet 8434_000-281

** Extended low frequency of 0,5 Hz available as M3 option

Product Overview

Shock/Impact/Impulse Measurements, Single Axis							High Impedance Charge Mode		
Model	Range ±g	Sensitivity pC/g	Threshold g_{rms}	Frequency Response Hz (±5%)	Mass grams	Connector Location & Type	Mounting Method & Thread Size	Ground Isolation	Page #
8044	-20 k... +30 k	-0,3	0,1	» 0 ... 8 k	7,0	top, 10-32	10-32 stud	no	27

Shock/Impact/Impulse Measurements, Single Axis							Low Impedance Voltage Mode		
Model	Range ±g	Sensitivity mV/g	Threshold g_{rms}	Frequency Response Hz (±5%)	Mass grams	Connector Location & Type	Mounting Method & Thread Size	Ground Isolation	Page #
8743A100	100 k	0,05	2,6	0,5 ... 10 k	4,5	integral to 10-32	10-32 stud, integral	no	38
8742A50	50 k	0,1	1,3	1 ... 10 k	4,5	top, 10-32	10-32 stud, integral	no	37
8742A20	20 k	0,25	0,5	1 ... 10 k	4,5	top, 10-32	10-32 stud, integral	no	37
8742A10	10 k	0,5	0,25	1 ... 10 k	4,5	top, 10-32	10-32 stud, integral	no	37
8742A5	5 k	1	0,13	1 ... 10 k	4,5	top, 10-32	10-32 stud, integral	no	37
8704B5000	5 k	1	0,13	1 ... 10 k	7,1	top, 10-32	10-32 stud	no	33

Miniature, Ultra Light Weight, Single Axis							Low Impedance Voltage Mode		
Model	Range ±g	Sensitivity mV/g	Threshold g_{rms}	Frequency Response Hz (±5%)	Mass grams	Connector Location & Type	Mounting Method & Thread Size	Ground Isolation	Page #
8614A1000M1	1000	2,5	0,04	10 ... 25 k	0,7	integral twisted wire pair to 10-32	wax or adhesive	with pad*	30
8614A500M1	500	4	0,025	10 ... 25 k	0,7	integral twisted wire pair to 10-32	wax or adhesive	with pad*	30
8730A500	500	10	0,02	2 ... 10 k	1,9	top, 10-32	5-40 stud, integral	no	36
8730AE500	500	10	0,02	2 ... 10 k	1,9	top, 10-32	M3 stud, integral	no	36
8730A500M1	500	10	0,02	2 ... 7 k	2,5	top, 10-32	5-40 stud, integral	yes	36
8732A500	500	10	0,01	2 ... 7 k	1,1	integral coax cable to 10-32	wax or adhesive	yes	36
8734A500	500	10	0,01	2 ... 7 k	1,2	integral coax cable to 10-32	screws	yes	36
8728A500	500	10	0,008	2 ... 10 k	1,6	integral coax cable to 10-32	wax or adhesive	no	35
8778A500	500	10	0,01	2 ... 9 k	0,29	integral coax cable to 10-32	wax or adhesive	yes	40

* Adhesive mounting pads made of aluminium with a hard anodized shell provide ground isolation, see datasheet 8434_000-281

Modal Analysis & Structural Testing, Single Axis							Low Impedance Voltage Mode		
Model	Range ±g	Sensitivity mV/g	Threshold g_{rms}	Frequency Response Hz (±5%)	Mass grams	Connector Location & Type	Mounting Method & Thread Size	Ground Isolation	Page #
8772A50	50	100	0,002	1 ... 5 k	8,0	side, 10-32	adh., wax or clip	yes	39
8632C50	50	100	0,001	1 ... 6 k	6,0	side, 10-32	wax or adhesive	yes	31
8636C50	50	100	0,001	1 ... 6 k	5,0	side, 10-32	5-40 stud	yes	31
8772A10	10	500	0,0005	1 ... 5 k	8,0	side, 10-32	adh., wax or clip	yes	39
8632C10	10	500	0,00028	1 ... 5 k	6,0	side, 10-32	wax or adhesive	yes	31
8636C10	10	500	0,00028	1 ... 5 k	5,0	side, 10-32	5-40 stud	yes	31
8772A5	5	1000	0,0004	1 ... 5 k	8,0	side, 10-32	adh., wax or clip	yes	39
8632C5	5	1000	0,00012	1 ... 3 k	6,0	side, 10-32	wax or adhesive	yes	31
8636C5	5	1000	0,00012	1 ... 3 k	5,0	side, 10-32	5-40 stud	yes	31

Product Overview

TEDS – Accelerometers, Single Axis								Low Impedance Voltage Mode	
Model	Range ±g	Sensitivity mV/g	Threshold g_{rms}	Frequency Response Hz (±5%)	Mass grams	Connector Location & Type	Mounting Method & Thread Size	Ground Isolation	Page #
8704B100T	100	50	0,01	0,6 ... 9 k	9,6	top, 10-32	10-32 stud	with pad*	32
8704B50T	50	100	0,006	3 ... 7 k	8,6	top, 10-32	10-32 stud	with pad*	32
8772A50T	50	100	0,002	1 ... 5 k	8,0	side, 10-32	adh., wax or clip	yes	39
8632C50T	50	100	0,001	1 ... 6 k	6,0	side, 10-32	wax or adhesive	yes	31
8704B25T	25	200	0,003	1 ... 9 k	8,6	top, 10-32	10-32 stud	with pad*	32
8772A10T	10	500	0,0005	1 ... 5 k	8,0	side, 10-32	adh., wax or clip	yes	39
8632C10T	10	500	0,00028	1 ... 5 k	6,0	side, 10-32	wax or adhesive	yes	31
8772A5T	5	1000	0,0004	1 ... 5 k	8,0	side, 10-32	adh., wax or clip	yes	39
8632C5T	5	1000	0,00012	1 ... 3 k	6,0	side, 10-32	wax or adhesive	yes	31

* Adhesive mounting pads made of aluminium with a hard anodized shell provide ground isolation, see datasheet 8434_000-281

High Temperature Vibration Measurements								Low Impedance Voltage Mode	
Model	Range ±g	Sensitivity mV/g	Threshold g_{rms}	Frequency Response Hz (±5%)	Mass grams	Connector Location & Type	Mounting Method & Thread Size	Ground Isolation	Page #
8702B500M5	500	10	0,01	2 ... 7 k	8,6	side, 10-32	10-32 stud	with pad*	33
8710A50M5	50	100	0,002	1 ... 7 k	43	side, 10-32	1/4-28 stud	yes	34
8752A50M5	50	100	0,002	1 ... 5 k	115	top MIL-C-5015	1/4-28 stud	yes	38
8794A500M5	500	10	0,002	1 ... 10 k	7,6	integral to 4-pin	4-40 cap screw	no	51
8793A500M5	500	10	0,002	1 ... 10 k	11	side, triax-4 pin	4-40 cap screw	no	51
8795A50M5	50	100	0,001	1 ... 4 k	32	side, triax-4 pin	10-32 stud	with pad*	52

* Adhesive mounting pads made of aluminium with a hard anodized shell provide ground isolation, see datasheet 8434_000-281

Low Temperature Vibration Measurements								Low Impedance Voltage Mode	
Model	Range ±g	Sensitivity mV/g	Threshold g_{rms}	Frequency Response Hz (±5%)	Mass grams	Connector Location & Type	Mounting Method & Thread Size	Ground Isolation	Page #
8702B500M8	500	10	0,01	2 ... 7 k	8,6	side, 10-32	10-32 stud	with pad*	33
8728A500M8	500	10	0,008	2 ... 10 k	1,6	integral to 10-32	wax or adhesive	no	35
8710A50M8	50	100	0,002	1 ... 7 k	43	side, 10-32	1/4-28 stud	yes	34
8793A500M8	500	10	0,002	1 ... 10 k	11	side, triax-4 pin	4-40 cap screw	no	51
8795A50M8	50	100	0,001	1 ... 4 k	32	side, triax-4 pin	10-32 stud	with pad*	52

* Adhesive mounting pads made of aluminium with a hard anodized shell provide ground isolation, see datasheet 8434_000-281

Product Overview

Acoustic Emission							Low Impedance Voltage Mode			
Model	Range $\pm g$	Sensitivity dB _{ref 1V (m/s)}	Threshold g_{rms}	Frequency Response Hz (± 10 dB)	Mass grams	Connector Location & Type	Mounting Method & Thread Size	Ground Isolation	Page #	
8152B1	N/A	57	N/A	50 k ... 400 k	29	integral to pigtails	M6 cap screw	yes	43	
8152B2	N/A	48	N/A	100 k ... 900 k	29	integral to pigtails	M6 cap screw	yes	43	

Low Amplitude, Low Frequency (0–300 Hz) Measurements, Triaxial								Voltage Output	
Model	Range $\pm g$	Sensitivity mV/g	Threshold g_{rms}	Frequency Response Hz (± 5 %)	Mass grams	Connector Location & Type	Mounting Method & Thread Size	Ground Isolation	Page #
8393A10	10	200	0,00283	0 ... 180	60	side, 9 pin micro D	4-40 cap screw	yes	45
8393A2	2	1000	0,00054	0 ... 300	60	side, 9 pin micro D	4-40 cap screw	yes	45

High Impedance Triaxial						High Impedance Charge Mode			
Model	Range $\pm g$	Sensitivity pC/g unless noted	Threshold g_{rms}	Frequency Response Hz (± 5 %)	Mass grams	Connector Location & Type	Mounting Method & Thread Size	Ground Isolation	Page #
8290A25M5	2 000	-25	0,001	5 ... 4 k	53	10-32 neg.	10-32 stud	no	45

General Purpose Vibration Measurement, Triaxial						Low Impedance Voltage Mode			
Model	Range $\pm g$	Sensitivity mV/g	Threshold g_{rms}	Frequency Response Hz (± 5 %)	Mass grams	Connector Location & Type	Mounting Method & Thread Size	Ground Isolation	Page #
8792A500	500	10	0,01	1 ... 5 k	29	side, triax-4 pin	through hole, 10-32 cap screw	yes	50
8793A500**	500	10	0,002	2,5 ... 10 k	11	side, triax-4 pin	4-40 cap screw	no	51
8794A500**	500	10	0,002	2,5 ... 10 k	7,6	integral triax cable to 4-pin	4-40 cap screw	no	51
8791A250	250	20	0,006	1 ... 2 k	4,0	integral triax cable to 4-pin	wax or adhesive	no	49
8792A100	100	50	0,009	0,5 ... 5 k	29	side, triax-4 pin	through hole, 10-32 cap screw	yes	50
8792A50	50	100	0,005	0,5 ... 5 k	29	side, triax-4 pin	through hole, 10-32 cap screw	yes	50
8795A50	50	100	0,001	1 ... 4 k	32	side, triax-4 pin	10-32 stud	with pad*	52
8792A25	25	200	0,003	1 ... 5 k	29	side, triax-4 pin	through hole, 10-32 cap screw	yes	50

* Adhesive mounting pads made of aluminium with a hard anodized shell provide ground isolation, see datasheet 8434_000-281

** Extended low frequency of 1 Hz available as M3 option

Product Overview

Miniature, Ultra Light Weight, Triaxial Low Impedance Voltage Mode

Model	Range ±g	Sensitivity mV/g	Threshold g_{rms}	Frequency Response Hz (±5%)	Mass grams	Connector Location & Type	Mounting Method & Thread Size	Ground Isolation	Page #
8694M1	500	4	0,025	10 ... 20 k	2,5	integral to 4-pin	wax or adhesive	with pad*	47

* Adhesive mounting pads made of aluminium with a hard anodized shell provide ground isolation, see datasheet 8434_000-281

Modal Analysis & Structural Testing, Triaxial Low Impedance Voltage Mode

Model	Range ±g	Sensitivity mV/g	Threshold g_{rms}	Frequency Response Hz (±5%)	Mass grams	Connector Location & Type	Mounting Method & Thread Size	Ground Isolation	Page #
8690C50	50	100	0,001	1 ... 6 k	11,2	side, triax-4 pin	wax or adhesive	yes	46
8692C50	50	100	0,001	1 ... 6 k	16	side, triax-4 pin	adhesive or magnet	yes	46
8692C50M1	50	100	0,001	1 ... 6 k	16	side, triax-4 pin	10-32 stud	yes	46
8690C10	10	500	0,00028	1 ... 5 k	11,2	side, triax-4 pin	wax or adhesive	yes	46
8692C10	10	500	0,00028	1 ... 5 k	16	triax-4 pin	adhesive or magnet	yes	46
8692C10M1	10	500	0,00028	1 ... 5 k	16	triax-4 pin	10-32 stud	yes	46
8690C5	5	1000	0,00012	1 ... 3 k	11,2	side, triax-4 pin	wax or adhesive	yes	46
8692C5	5	1000	0,00012	1 ... 3 k	16	triax-4 pin	adhesive or magnet	yes	46
8692C5M1	5	1000	0,00012	1 ... 3 k	16	triax-4 pin	10-32 stud	yes	46

TEDS – Accelerometers, Triaxial Low Impedance Voltage Mode

Model	Range ±g	Sensitivity mV/g	Threshold g_{rms}	Frequency Response Hz (±5%)	Mass grams	Connector Location & Type	Mounting Method & Thread Size	Ground Isolation	Page #
8793A500T	500	10	0,002	1 ... 10 k	11	side, triax-4 pin	4-40 cap screw	no	51
8690C50T	50	100	0,001	1 ... 6 k	11,2	side, triax-4 pin	wax or adhesive	yes	46
8795A50T	50	100	0,001	1 ... 4 k	32	side, triax-4 pin	10-32 stud	with pad*	52
8690C10T	10	500	0,00028	1 ... 5 k	11,2	side, triax-4 pin	wax or adhesive	yes	46
8690C5T	5	1000	0,00012	1 ... 3 k	11,2	side, triax-4 pin	wax or adhesive	yes	46

* Adhesive mounting pads made of aluminium with a hard anodized shell provide ground isolation, see datasheet 8434_000-281

Product Overview

Special Accelerometer Types

Axial Rotational, Single Axis									Voltage output
Model	Range krads/s ²	Sensitivity µV/rad/s ²	Threshold rads/s ²	Frequency Response Hz (±5%)	Mass grams	Connector Location & Type	Mounting Method & Thread Size	Ground Isolation	Page #
8838	±150	34	4	1 ... 2 k	18,5	side, 4 pin	through hole, 10-32 cap screw	yes	41

Lateral Rotational, Single Axis									Voltage output
Model	Range krads/s ²	Sensitivity µV/rad/s ²	Threshold rads/s ²	Frequency Response Hz (±5%)	Mass grams	Connector Location & Type	Mounting Method & Thread Size	Ground Isolation	Page #
8840	±150	34	4	1 ... 2 k	18,5	side, 4 pin	through hole, 10-32 cap screw	yes	41

TEDS Templates	
Suffix No.	TEDS Templates
T	Default – IEEE1451.4 v0.9 template 0 (UTID 1)
T01	IEEE1451.4 v0.9 template 24 (UTID 116225)
T02	LMS template 117 free form at pont ID
T03	LMS template 118, automotive format (field 14 geometry = 0)
T04	LMS template 118, aerospace format (field 14 geometry = 1)
T05	IEEE1451.4 v1.0 template 25, transfer function disabled
T06	IEEE1451.4 v1.0 template 25, transfer function enabled

- M1 Ground isolated
- M2 Long time constant (Piezoelectric)
Single polarity power supply and differential output (K-Beam)
- M3 Long time constant and ground isolated
- M4 Integral cable terminated in 4-pin positive connector
- M5 High temperature (166 °C)
- M6 Integral stud
- M7 Integral cable terminated in 4-pin negative connector
- M8 Cryogenic/Low temperature (-195 °C)
- M11 Integral cable terminated in pigtail
- T TEDS

Acceleration

Single axis static/low frequency accelerometer options include integral cable, environmentally sealed and hermetic configurations. Case or base isolation is provided by a durable, hard anodized aluminium construction. Some types operate symmetrically about a 2,5 volt DC voltage and others provide an output symmetric about a zero volt baseline. Integral cable types provide the necessary measurement performance characteristics in an economical package while the four pin connector types provide an improved seal, replaceable cable and some advanced signal conditioning. The 8310's offer an internal temperature sensor thereby providing a means of subsequent temperature compensation.



Acceleration

Variable Capacitance Accelerometer

K-Beam Capacitive Accelerometer Type 8305A...

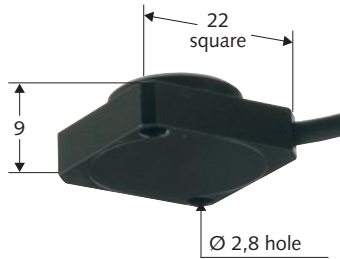

Measuring direction **Connection**
 Std.: pigtail
 M2: pigtail

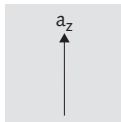

Specifications		Type	Type
		8305A2	8305A10
Range	g	±2	±10
Sensitivity, ±5 %	mV/g	500	100
Output at Zero g, ±5 %	V	2,5	2,5
Frequency Response, +5 %	Hz	0 ... 200	0 ... 180
Non-Linearity	%FSO	±0,4	±0,4
Resolution/Threshold	µg	280	1410
Transverse Sensitivity typ.	%	1	1
Shock (0,5 ms half sine)	g	6 000	6 000
Temp. Coeff.: Bias typ.	mg/°C	0,2	1
	Sensitivity typ.	%/°C	0,02
Phase Shift max. @ 100 Hz	deg.	20	20
Operating Temperature	°C	-40 ... 85	-40 ... 85
Power Supply	mA	0,7	0,7
	VDC	7 ... 16	7 ... 16
Housing/Base	type	Al., hard anodized	
Sealing	type	Epoxy	Epoxy
Mass	gram	6,5	6,5

M2 versions, operate from a single polarity supply and provides a differential output.

Characteristics
 Small, lightweight variable capacitance sensing element, can be operated from a 9 volt battery, CE compliant

Applications
 Low frequency vibration measurements

Accessories
 Power supply: Type 5210
 Mounting cube: Type 8516

Datasheet 8305A_000-217

K-Beam Capacitive Accelerometer Type 8310A...

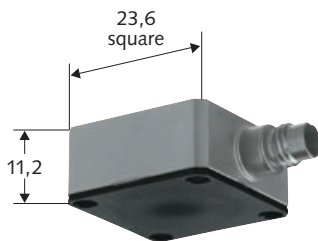

Measuring direction **Connection**
 4-pin pos.

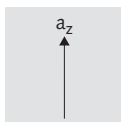

Specifications		Type	Type
		8310A2	8310A10
Range	g	±2	±10
Sensitivity, ±5 %	mV/g	1000	200
Output at Zero g	V	±30	±30
Frequency Response, ±5 %	Hz	0 ... 250	0 ... 180
Non-Linearity	%FSO	±0,8	±0,8
Resolution/Threshold	µg	540	2 830
Transverse Sensitivity typ.	%	1	1
Shock (0,7 ms half sine)	g	6 000	6 000
Temp. Coeff.: Bias typ.	mg/°C	0,2	1
	Sensitivity typ.	%/°C	0,02
Phase Shift max. @ 100 Hz	deg.	20	20
Operating Temperature	°C	-40 ... 85	-40 ... 85
Power Supply	mA	1,3	1,3
	VDC	3,8 ... 16	3,8 ... 16
Housing/Insulator Base	type	Titanium/Al., hard anodized	
Sealing	type	Hermetic	Hermetic
Ground Isolation	MΩ	10	10
Mass	gram	17	17

Characteristics
 Low Power, 1,3 mA, bipolar output, 2 V FS, zero volt output at zero g, CE compliant, temperature output provided
 M11: includes integral cable

Applications
 Vehicle ride quality studies, structural analysis, building & bridge vibration

Accessories
 Cable: Type 1592A..., 1592M1..., 1786C...
 Power supply: Type 5210
 Mounting cube: Type 8518A

Datasheet 8310A_000-218

Acceleration

Variable Capacitance Accelerometer

K-Beam Capacitive Accelerometer Type 8310A...

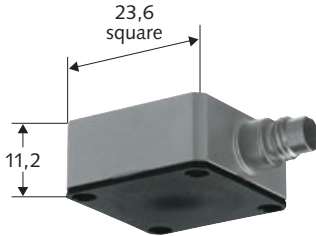

Specifications		Type	Type
		8310A25A1	8310A50
Range	g	±25	±50
Sensitivity, ±5 %	mV/g	80	40
Output at Zero g	V	±40	±40
Frequency Response, ±5 %	Hz	0 ... 300	0 ... 500
Non-Linearity	%FSO	±1	±1
Resolution/Threshold	µg	2 940	5 700
Transverse Sensitivity typ.	%	2	2
Shock (0,7 ms half sine)	g	3 000	3 000
Temp. Coeff.: Bias typ.	mg/°C	3	5
	Sensitivity typ.	%/°C	0,02
Phase Shift max. @ 100 Hz	deg.	20	20
Operating Temperature	°C	-40 ... 85	-40 ... 85
Power Supply	mA	13	13
	VDC	6 ... 16	6 ... 16
Housing/Insulator Base	type	Titanium/Al., hard anodized	
Sealing	type	Hermetic	Hermetic
Ground Isolation	MΩ	10	10
Mass	gram	17	17

Measuring direction Connection
4-pin pos.

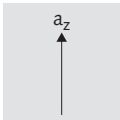

Characteristics

Low Power, 1,3 mA, bipolar output, 2 V FS, zero volt output at zero g, CE compliant, temperature output provided
M11: includes integral cable

Applications

Vehicle ride quality studies, structural analysis, building & bridge vibration

Accessories

Cable: Type 1592A..., 1592M1..., 1786C...
Power supply: Type 5210
Mounting cube: Type 8518A

Datasheet 8310A_000-218

Acceleration

Variable Capacitance Accelerometer

K-Beam Capacitive Accelerometer Type 8312A...

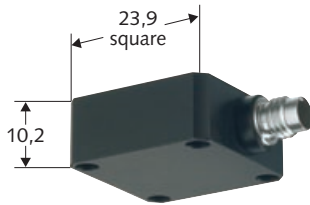

Specifications		Type	Type
		8312A2	8312A10
Range	g	±2	±10
Sensitivity, ±5 %	mV/g	1000	200
Output at Zero g	V	0	0
Frequency Response, ±5 %	Hz	0 ... 250	0 ... 180
Non-Linearity	%FSO	±0,8	±0,8
Resolution/Threshold	µg	540	2 830
Transverse Sensitivity typ.	%	1	1
Shock (500 µs half sine)	g	6 000	6 000
Temp. Coeff.: Bias typ.	mg/°C	0,2	1
Sensitivity typ.	%/°C	0,02	0,02
Phase Shift max. @ 100 Hz	deg.	20	20
Operating Temperature	°C	-40 ... 85	-40 ... 85
Power Supply	mA	1,3	1,3
	VDC	3,8 ... 16	3,8 ... 16
Housing/Base	type	Al., hard anodized	
Sealing	type	Epoxy	Epoxy
Ground Isolation	MΩ	10	10
Mass	gram	12	12

Measuring direction Connection
4-pin pos.

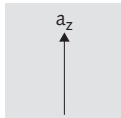

Characteristics
Low power, zero volt output at zero g, bipolar output: ±2 V FS, CE compliant

Applications
Vehicle ride quality studies, structural analysis, building & bridge vibration

Accessories
Cable: Type 1592A..., 1592M1..., 1786C...
Power supply: Type 5210
Mounting cube: Type 8518

Datasheet 8312A_000-219

ServoK-Beam Capacitive Accelerometer Type 8330A...

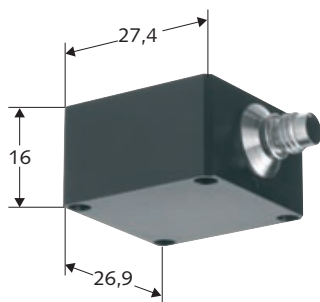

Specifications		Type
		8330A2,5
Range	g	±2,5
Sensitivity, ±5 %	mV/g	1500
Frequency Response, ±5 %	Hz	0 ... 200
Non-Linearity	%FSO	±0,2
Resolution/Threshold	µg	<2,5
Transverse Sensitivity typ.	%	0,4
Shock (500 µs half sine)	g	1500
Temp. Coeff.: Bias typ.	mg/°C	0,2
Sensitivity typ.	%/°C	0,0055
Phase Shift max. @ 100 Hz	deg.	-1
Operating Temperature	°C	-40 ... 85
Power Supply	mA	8,5
	VDC	±6 ... ±15
Housing/Base	type	Aluminium, hard anodized
Sealing	type	Epoxy
Ground Isolation	MΩ	10
Mass	gram	28,5

Measuring direction Connection
4-pin pos.

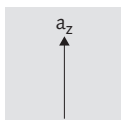

Characteristics
Variable capacitance analogue force feedback operation, zero volt output at zero g, ultra low noise, CE compliant

Applications
Low frequency, low amplitude vibration measurements typical to critical machine process control

Accessories
Cable: Type 1592M1..., 1788A...
Mounting cube: Type 8530

Datasheet 8330A_000-242

Vibration

Single axis accelerometers are available in many configurations to accommodate the widely varying test conditions. Critical constraints often include size, weight, sensitivity, frequency response, etc. These variables are interrelated, therefore a compromise must be established during the selection process. Accelerometer families have been created with an optimized set of parameters intended for a particular field of testing. Dynamic accelerometer families include PiezoBeam, Ceramic Shear, and the K-Shear constructions. Typically the PiezoBeam family provides high output in an economical, lightweight package tuned for a Modal Analysis environment. Ceramic Shear types provide improved thermal transient characteristics. K-Shear offers high quality, general-purpose capability covering the widest range of applications. Further classification provides focus to important criteria such as miniature size or high temperature capability.



Vibration

Charge Output

Quartz Accelerometers Type 8002...

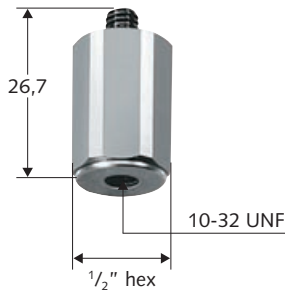

Measuring direction a_z
 Connection 10-32 neg.

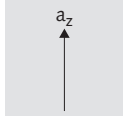

Specifications	Type 8002	
Range	g	± 1000
Sensitivity	pC/g	-1,0
Frequency Response, -1 ... 5%	Hz	$\approx 0 \dots 6000$
Threshold nom.	g _{rms}	0,02
Transverse Sensitivity max.	%	5
Non-Linearity	%FSO	± 1
Temp. Coeff. of Sensitivity	%/°C	-0,03
Operating Temperature	°C	-195 ... 260
Housing/Base	type	St. Stl.
Sealing	type	Epoxy
Mass	gram	20
Sensing Element	type	Quartz/compression

Characteristics
 High impedance, charge mode, quartz stability and repeatability, wide operating temperature range.
 *for the 8002K refer to page 80

Applications
 Used with 5022 to form a complete calibration primary standard. Long duration shock pulses or high frequency vibrations even in cryogenic or high temperature environments.

Accessories
 Mounting Stud: Type 8402
 Cable: 1631C...
 Charge Amplifier: 5022
Datasheet 8002_000-205

High Impact Quartz Compression Accelerometer Type 8044

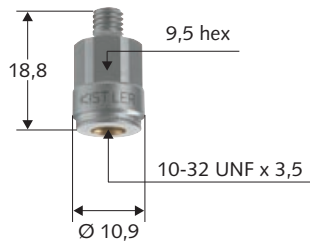

Measuring direction a_z
 Connection 10-32 neg.

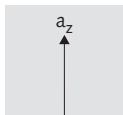

Specifications	Type 8044	
Range	g	-20 k ... 30 k
Sensitivity, $\pm 5\%$	pC/g	-0,3
Frequency Response, $\pm 5\%$	Hz	$\sim 0 \dots 8 \text{ k}$
Threshold	g _{rms}	0,07
Transverse Sensitivity typ.	%	<5
Non-Linearity	%FSO	± 1
Shock (1 ms pulse)	g	100 k
Temp. Coeff. of Sensitivity	%/°C	0,02
Operating Temperature	°C	-195 ... 205
Housing/Base	type	St. Stl.
Sealing	type	Welded/Epoxy
Mass	gram	7
Insulation Resistance	Ω	$\geq 10^{13}$

Characteristics
 High impedance charge mode, wide measuring range, stable quartz element, lightweight, miniature package

Applications
 Measuring and analyzing shock and vibration with very high amplitudes of acceleration

Accessories
 Cable: Type 1631C...
 Charge amplifier: Type 5000 series

Datasheet 8044_000-209

Vibration

Charge Output, Extreme Temperature

Ceramic Shear Accelerometer Type 8202A...

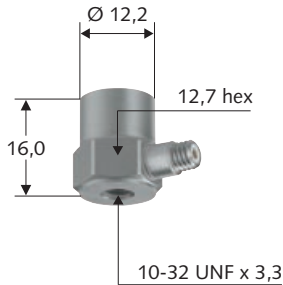

Specifications	Type 8202A10	
Range	g	±2 000
Sensitivity, ±5 %	pC/g	-10
Frequency Response, ±5 %	Hz	5 ... 10 k
Threshold	g_{rms}	0,001
Transverse Sensitivity typ.	%	1,5
Non-Linearity	%FSO	±1
Shock (1 ms pulse)	g	5 000
Temp. Coeff. of Sensitivity	%/°C	0,14
Operating Temperature	°C	-70 ... 250
Housing/Base	type	St. Stl.
Sealing	type	Hermetic
Mass	gram	14,5
Insulation Resistance	Ω	$\geq 10^{13}$

Measuring direction Connection

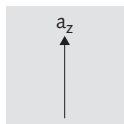

10-32 neg.

Characteristics

High impedance, charge mode, high temp 250 °C, ceramic shear sensing element, low transverse sensitivity, two year warranty

Applications

Automotive, aerospace and environmental testing where low impedance sensors are limited by temperature range

Accessories

Cable: Type 1631C...
Charge amplifier:
Type 5000 series

Datasheet 8202A_000-212

Ceramic Shear Accelerometer Type 8203A...

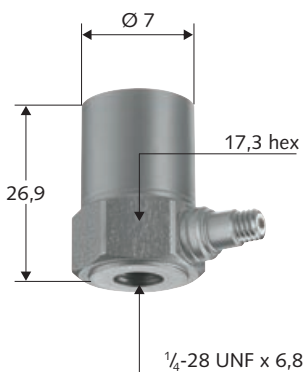

Specifications	Type 8203A50	
Range	g	±1000
Sensitivity, ±5 %	pC/g	-50
Frequency Response, ±5 %	Hz	5 ... 4 k
Threshold	g_{rms}	0,006
Transverse Sensitivity typ.	%	1,5
Non-Linearity	%FSO	±1
Shock (1 ms pulse)	g	5 000
Temp. Coeff. of Sensitivity	%/°C	0,14
Operating Temperature	°C	-70 ... 250
Housing/Base	type	St. Stl.
Sealing	type	Hermetic
Mass	gram	44,5

Measuring direction Connection

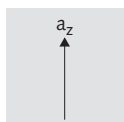

10-32 neg.

Characteristics

High impedance, charge mode, high temp 250 °C, ceramic shear sensing element, low transverse sensitivity, two year warranty

Applications

Automotive, aerospace and environmental testing where low impedance sensors are limited by temperature range

Accessories

Cable: Type 1631C...
Charge amplifier:
Type 5000 series

Datasheet 8202A_000-212

Vibration

Charge Output

Ceramic Shear Accelerometer Type 8274A...

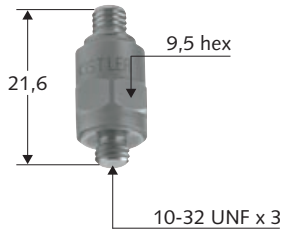

Specifications	Type 8274A5	
Range	g	±2 000
Sensitivity	pC/g	-5,5
Frequency Response, ±7%	Hz	1 ... 12k
Non-Linearity	%FSO	±1
Resolution/Threshold	g_{rms}	0,01
Transverse Sensitivity typ.	%	1,5
Shock (1 ms pulse)	g	5 000
Temp. Coeff. Sensitivity typ.	%/°C	0,10
Operating Temperature	°C	-54 ... 165
Housing/Insulator Base	type	Titanium
Sealing	type	Hermetic
Mass	gram	4

Measuring direction a_z
 Connection 10-32 neg.

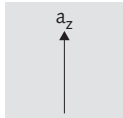

Characteristics
 High impedance, ceramic shear sensing element, wide frequency response, low transverse sensitivity, lightweight, rugged connector, priced for OEM applications

Applications
 Impact and vibration related applications including condition monitoring and vehicle testing

Accessories
 Cable: Type 1631C...
 Charge amplifier: Type 5000 series
 Adh. mounting pad: Type 8436
 Mounting magnet: Type 8452A
 Mounting cube: Type 8524
 Mounting cube: Type 8526

Datasheet 8274A_000-213

Ceramic Shear Accelerometer Type 8276A...

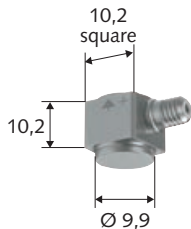

Specifications	Type 8276A5	
Range	g	±2 000
Sensitivity	pC/g	-5,5
Frequency Response, ±5%	Hz	1 ... 7 k
Non-Linearity	%FSO	±1
Threshold	g_{rms}	0,01
Transverse Sensitivity typ.	%	1,5
Shock (1 ms pulse)	g	5 000
Temp. Coeff. Sensitivity typ.	%/°C	0,10
Operating Temperature	°C	-54 ... 165
Housing/Insulator Base	type	Titanium
Sealing	type	Hermetic
Mass	gram	4

Measuring direction a_z
 Connection 10-32 neg.

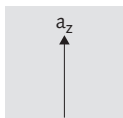

Characteristics
 High impedance, ceramic shear sensing element, wide frequency response, low transverse sensitivity, lightweight, rugged connector, priced for OEM applications

Applications
 Impact and vibration related applications including condition monitoring and vehicle testing

Accessories
 Cable: Type 1631C...
 Charge amplifier: Type 5000 series
 Adh. mounting pad: Type 8436
 Mounting magnet: Type 8452A
 Mounting cube: Type 8524
 Mounting cube: Type 8526

Datasheet 8274A_000-213

Vibration

Voltage Output, Piezotron Accelerometer

Piezotron Ceramic Shear Accelerometer Type 8141

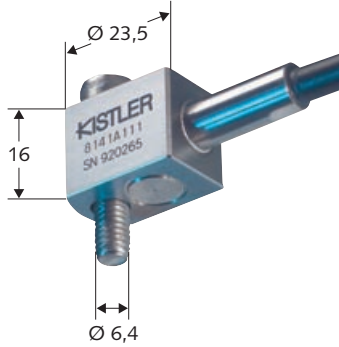

Specifications	Type 8141	
Range	g	±50
Sensitivity	mV/g	100
Frequency Response, ±5%	Hz	10 ... 6 k
Threshold	g_{rms}	0,002
Transverse Sensitivity	%	2
Non-Linearity	%FSO	1
Shock (1 ms pulse)	g	±5 000
Temp. Coeff. of Sensitivity	%/°C	0,14
Operating Temperature	°C	-40 ... 80
Power Supply	mA	3 ... 6
	VDC	20 ... 30
Housing/Base	type	St. Stl.
Sealing	type	Hermetic
Ground Isolation	MΩ	10
Mass	gram	30
Mounting	type	Cap screw M8 x 25

Measuring direction a_z
 Connection pigtails

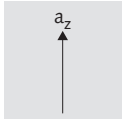

Characteristics
 Rugged, hermetically sealed construction with durable integral cable. Piezoceramic shear sensing elements. CE compliant

Applications
 Measurement of vibration on machine structures, bearing monitoring, machine tools or as a built-in integral component of a machine diagnostic system

Accessories
 Coupler: Type 5127B
 Datasheet 8141_000-203

Picotron Miniature Quartz Compression Accelerometer Type 8614A...

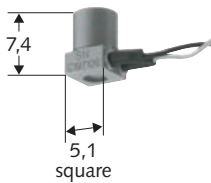

Specifications	Type		
	8614A500M1	8614A1000M1	
Range	g	±500	±1000
Sensitivity, ±5%	mV/g	4	2,5
Frequency Response, ±5%	Hz	10 ... 25 k	10 ... 25 k
Threshold	g_{rms}	0,025	0,04
Transverse Sensitivity typ.	%	<5	<5
Non-Linearity	%FSO	±1	±1
Shock (1 ms pulse)	g	-500 ... 10 k	±2 000
Temp. Coeff. of Sensitivity	%/°C	-0,06	-0,06
Operating Temperature	°C	-54 ... 121	-54 ... 121
Power Supply	mA	2 ... 18	2 ... 18
	VDC	20 ... 30	20 ... 30
Housing/Base	type	Titanium	Titanium
Sealing	type	Epoxy	Epoxy
Mass	gram	0,7	0,7

Measuring direction a_z
 Connection 10-32 neg.

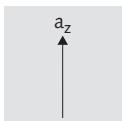

Characteristics
 Low impedance voltage mode, small and lightweight, very high resonant frequency, CE compliant

Applications
 P.C. board component shock and vibration testing, monitoring missile and aircraft vibration; high speed rotating component equipment performance and wear signature; and vibration responses of thin-walled structures

Accessories
 Cable: Type 1761B...
 Coupler: Type 5100 series
 Datasheet 8614A_000-225

Vibration

Voltage Output, Piezotron Accelerometer

PiezoBeam Cube Accelerometer Type 8632C...



Specifications		Type 8632C5	Type 8632C10	Type 8632C50
Range	g	±5	±10	±50
Sensitivity, ±5 %	mV/g	1000	500	100
Frequency Response, ±5 %	Hz	1 ... 3 k	1 ... 5 k	1 ... 6 k
Threshold	μg _{rms}	120	280	1000
Transverse Sensitivity	%	<1	<1	<1
Non-Linearity	%FSO	±1	±1	±1
Shock (0,2 ms pulse)	g	7 000	10 000	10 000
Temp. Coeff. of Sensitivity	%/°C	-0,04	0,08	0,08
Operating Temperature	°C	0 ... 65	0 ... 65	0 ... 65
Power Supply	mA	2 ... 18	2 ... 18	2 ... 18
	VDC	20 ... 30	20 ... 30	20 ... 30
Housing/Base	type	Al., hard anodized		
Sealing	type	Epoxy	Epoxy	Epoxy
Ground Isolation	MΩ	10	10	10
Mass	gram	6	6	6

Measuring direction **Connection**
10-32 neg.

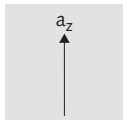

Characteristics
Low impedance voltage mode, high sensitivity, small cubic design, ground isolated, CE compliant
T: TEDS option available

Applications
Modal analysis or structural investigations in thermally stable environments

Accessories
Cable: Type 1761B...
Coupler: Type 5100 series
Datasheet 8632C_000-229

PiezoBeam Accelerometer Type 8636C...

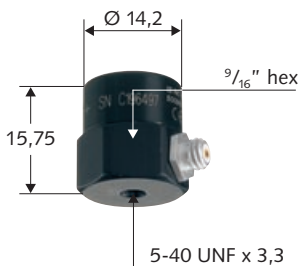

Specifications		Type 8636C5	Type 8636C10	Type 8636C50
Range	g	±5	±10	±50
Sensitivity, ±5 %	mV/g	1000	500	100
Frequency Response, ±5 %	Hz	1 ... 3 k	1 ... 5 k	1 ... 6 k
Threshold	μg _{rms}	120	280	1000
Transverse Sensitivity	%	<1	<1	<1
Non-Linearity	%FSO	±1	±1	±1
Shock (0,2 ms pulse)	g	7 000	10 000	10 000
Temp. Coeff. of Sensitivity	%/°C	-0,04	0,08	0,08
Operating Temperature	°C	0 ... 65	0 ... 65	0 ... 65
Power Supply	mA	2 ... 18	2 ... 18	2 ... 18
	VDC	20 ... 30	20 ... 30	20 ... 30
Housing/Base	type	Al., hard anodized		
Sealing	type	Epoxy	Epoxy	Epoxy
Ground Isolation	MΩ	10	10	10
Mass	gram	5,5	5,5	5,5

Measuring direction **Connection**
10-32 neg.

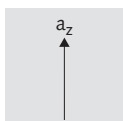

Characteristics
High sensitivity, very low noise, dynamic range >90 dB, low transverse sensitivity, CE compliant

Applications
Low frequency measurements, vibrations & oscillations in mechanical structures and for modal analysis in thermally stable environments

Accessories
Cable: Type 1761B...
Coupler: Type 5100 series
Adh. mounting pad: Type 8434
Mounting magnet: Type 8450A
Datasheet 8630C_000-227

Vibration

Voltage Output, Piezotron Accelerometer

Piezotron Vibration Standard Accelerometer Type 8676K

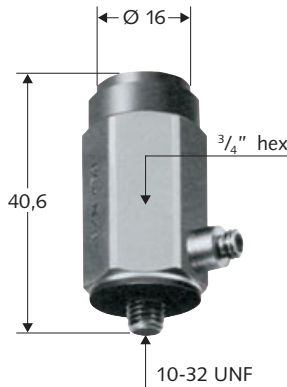

Measuring direction a_z
 Connection 10-32 neg.

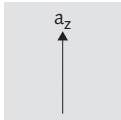

Specifications	Type 8676K	
Range	g	±250
Sensitivity (+10%, -2%)	mV/g	10
Frequency Response, ±5%	Hz	20 ... 5 000
Threshold nom.	g_{rms}	0,01
Transverse Sensitivity max.	%	2
Non-Linearity	%FSO	± 0,5
Shock Limit (1ms pulse)	g	1000
Temp. Coeff. of Sensitivity	%/°C	-0,02
Operating Temperature	°C	-15 ... 65
Power Supply	mA	4 ... 20
	VDC	20 ... 28
Housing/Base	type	St. Stl.
Sealing	type	Epoxy
Mass	gram	80
Sensing Element	type	Quartz/compression

Characteristics
 Quartz accuracy and stability, rugged design, low base strain sensitivity, low mass loading sensitivity, ground isolated

Applications
 Transfer standard for back-to-back calibration of accelerometers field calibrations.

Accessories
 Mounting Stud: Type 8410
 Thread Converter: Type 8414
 Cable: 1761B...
 Coupler: 5100 series

Datasheet 8676K_000-233

K-Shear Accelerometer Type 8702B..., 8704B...

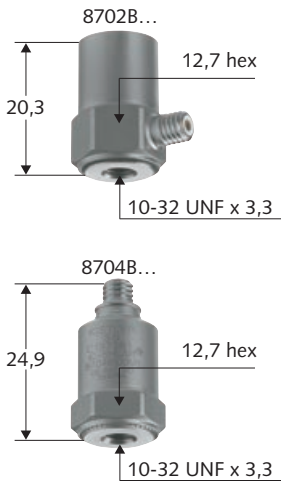

Measuring direction a_z
 Connection 10-32 neg.

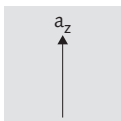

Specifications	Type 8702/04B25	Type 8702/04B50	Type 8702/04B100	
Range	g	± 25	±50	±100
Sensitivity, ±5%	mV/g	200	100	50
Frequency Response, ±5%	Hz	1,0 ... 8 k	0,5 ... 10 k	0,5 ... 10 k
Threshold	g_{rms}	0,002	0,004	0,006
Transverse Sensitivity typ.	%	1,5	1,5	1,5
Non-Linearity	%FSO	±1	±1	±1
Shock (1 ms pulse)	g	2 000	2 000	2 000
Temp. Coeff. of Sensitivity	%/°C	-0,06	-0,06	-0,06
Operating Temperature	°C	-54 ... 100	-54 ... 100	-54 ... 100
Power Supply	mA	4	4	4
	VDC	20 ... 30	20 ... 30	20 ... 30
Housing/Base	type	Titanium	Titanium	Titanium
Sealing	type	Hermetic	Hermetic	Hermetic
Mass (8702)	gram	8,7	8,7	8,7
Mass (8704)	gram	7,5	7,5	7,5

Characteristics
 Low impedance voltage mode, ultra low base strain, low thermal transient response, quartz-shear sensing elements, CE compliant
 M1: ground isolated
 T: TEDS option available

Applications
 General purpose vibration measurement, vehicle or environmental testing, ESS and modal analysis

Accessories
 Cable: Type 1761B...
 Coupler: Type 5100 series

Datasheet 8702B_000-239

Vibration

Voltage Output, Piezotron Accelerometer

K-Shear Shock Accelerometer Type 8704B5000

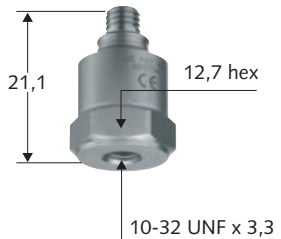

Specifications		Type 8704B5000
Range	g	±5 000
Sensitivity, ±5 %	mV/g	1
Frequency Response, ±5 %	Hz	1 ... 10 k
Threshold	g_{rms}	0,13
Transverse Sensitivity typ.	%	1,5
Non-Linearity	%FSO	±1
Shock (1 ms pulse)	g	10 000
Temp. Coeff. of Sensitivity	%/°C	-0,03
Operating Temperature	°C	-54 ... 120
Power Supply	mA	4
	VDC	20 ... 30
Housing/Base	type	Titanium
Sealing	type	Hermetic
Mass	gram	7,1

Measuring direction Connection

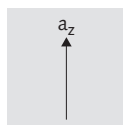

10-32 neg.

Characteristics

Low impedance voltage mode, quartz-shear sensing elements ultra-low base strain, ultra low thermal transient response, CE compliant

Applications

Measurement and control during mechanical shock testing

Accessories

Cable: Type 1761B...
Coupler: Type 5100 series

Datasheet 8704B_000-240

K-Shear Accelerometer Type 8702B..., 8704B...

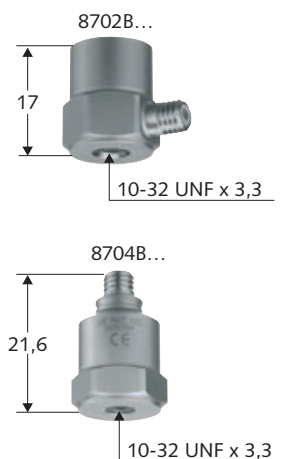

Specifications		Type 8702B500	Type 8704B500
Range	g	±500	±500
Sensitivity, ±5 %	mV/g	10	10
Frequency Response	Hz	1...10 k	1...10 k
Threshold	g_{rms}	0,01	0,01
Transverse Sensitivity typ.	%	1,5	1,5
Non-Linearity	%FSO	±1	±1
Shock (1 ms pulse)	g	5 000	5 000
Temp. Coeff. of Sensitivity	%/°C	-0,03	-0,03
Operating Temperature	°C	-54 ... 120	-54 ... 120
Power Supply	mA	4	4
	VDC	20 ... 30	20 ... 30
Housing/Base	type	Titanium	Titanium
Sealing	type	Hermetic	Hermetic
Mass	gram	8,2	7,1

Measuring direction Connection

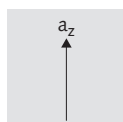

10-32 neg.

Characteristics

Low impedance voltage mode, ultra low base strain, low thermal transient response, quartz-shear sensing elements, CE compliant

M1: ground isolated

M3: low freq. and ground isolated

M5: high temp. (166 °C)

M8: low temp. (-196 °C)

T: TEDS option available

Applications

General purpose vibration measurement, vehicle or environmental testing, ESS and modal analysis

Accessories

Cable: Type 1761B...
Coupler: Type 5100 series

Datasheet 8702B_000-238

Vibration

Voltage Output, Piezotron Accelerometer

K-Shear Continuous Duty Accelerometer Type 8710A...

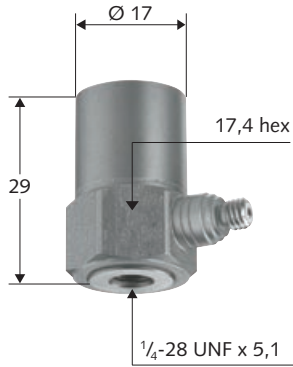

Specifications		Type		
		8710A50M1	8710A50M5	8710A50M8
Range	g	±50	±50	±50
Sensitivity, ±5 %	mV/g	100	100	100
Frequency Response, ±5 %	Hz	0,3 ... 7 k	1 ... 7 k	1 ... 7 k
Threshold	g_{rms}	0,002	0,002	0,002
Transverse Sensitivity typ.	%	1,5	1,5	1,5
Non-Linearity	%FSO	±1	±1	±1
Shock (1 ms pulse)	g	2 000	2 000	2 000
Temp. Coeff. of Sensitivity	%/°C	-0,03	-0,03	-0,03
Operating Temperature	°C	-54 ... 120	-54 ... 165	-195 ... 120
Power Supply	mA	2 ... 18	2 ... 18	2 ... 18
	VDC	20 ... 30	20 ... 30	20 ... 30
Housing/Base	type	St. Stl.	Titanium	Titanium
Sealing	type	Hermetic	Hermetic	Hermetic
Ground Isolation	MΩ	10	10	10
Mass	gram	43	29	29

Measuring direction Connection
10-32 neg.

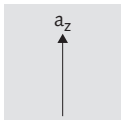

Characteristics

Low impedance voltage mode, ultra low thermal transient response, ground isolated, CE compliant
M5: high temp. (166 °C)
M8: low temp. (-196 °C)

Application

Testing applications where a rugged accelerometer with a wide frequency range is required: Precision automotive testings, ESS and industrial applications

Accessories

Cable: Type 1631C..., 1761B..., 1939
Coupler: Type 5100 series

Datasheet 8710A_000-241

K-Shear High Sensitivity Accelerometer Type 8712A...

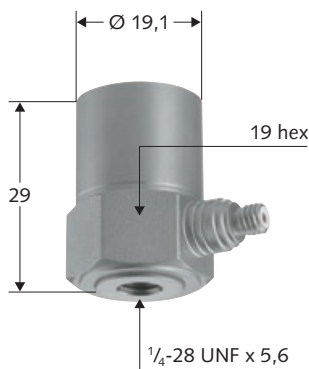

Specifications	Type	
	8712A5M1	
Range	g	±5
Sensitivity, ±5 %	mV/g	1000
Frequency Response, ±5 %	Hz	0,5 ... 8 k
Threshold	g_{rms}	0,0004
Transverse Sensitivity typ.	%	1,5
Non-Linearity	%FSO	±1
Shock (1 ms pulse)	g	1000
Temp. Coeff. of Sensitivity	%/°C	-0,06
Operating Temperature	°C	-54 ... 100
Power Supply	mA	4
	VDC	20 ... 30
Housing/Base	type	St. Stl.
Sealing	type	Hermetic
Ground Isolation	MΩ	10
Mass	gram	51

Measuring direction Connection
10-32 neg.

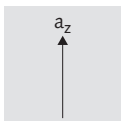

Characteristics

Low impedance voltage mode, very high sensitivity, quartz-shear accuracy & stability, high immunity to thermal transients, welded hermetic construction, ground isolated, CE compliant

Applications

Applications involving low amplitude vibrations over a wide frequency range. Examples include heavy structures, suspension vibration building and machines

Accessories

Cable: Type 1761B...
Coupler: Type 5100 series

Datasheet 8712A_000-244

Vibration

Voltage Output, Piezotron Accelerometer

K-Shear Accelerometer Type 8720A...

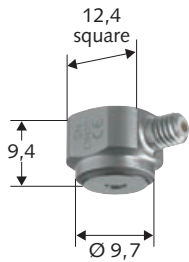

Specifications	Type 8720A500	
Range	g	±500
Sensitivity, ±5 %	mV/g	10
Frequency Response, ±5 %	Hz	1 ... 9 k
Threshold	g_{rms}	0,01
Transverse Sensitivity typ.	%	1,5
Non-Linearity	%FSO	±1
Shock (1 ms pulse)	g	5 000
Temp. Coeff. of Sensitivity	%/°C	-0,06
Operating Temperature	°C	-54 ... 120
Power Supply	mA	4
	VDC	20 ... 30
Housing/Base	type	Titanium
Sealing	type	Hermetic
Ground Isolation	MΩ	10
Mass	gram	4,9

Measuring direction Connection
10-32 neg.

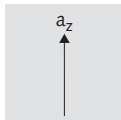

Characteristics
Low impedance, voltage mode, quartz-shear sensing element, ultra low base strain sensitivity, ultra low thermal transients, lightweight, small size, ground isolated, CE compliant

Applications
Modal analysis and measurement on light structures, the small size allows for installation on items with limited mounting space

Accessories
Cable: Type 1761B...
Coupler: Type 5100 series
Datasheet 8720A_000-246

K-Shear Miniature Accelerometer Type 8728A...

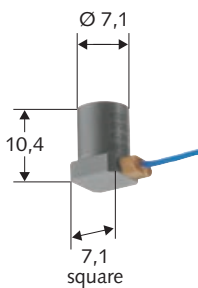

Specifications	Type 8728A500	
Range	g	±500
Sensitivity, ±5 %	mV/g	10
Frequency Response, ±5 %	Hz	2 ... 10 k
Threshold	g_{rms}	0,02
Transverse Sensitivity typ.	%	1,5
Non-Linearity	%FSO	±1
Shock (1 ms pulse)	g	5 000
Temp. Coeff. of Sensitivity	%/°C	-0,06
Operating Temperature	°C	-54 ... 120
Power Supply	mA	2 ... 18
	VDC	20 ... 30
Housing/Base	type	Titanium
Sealing	type	Epoxy
Mass	gram	1,6

Measuring direction Connection
10-32 neg.

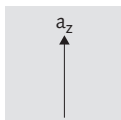

Characteristics
Low impedance voltage mode, small, lightweight. integral cable, quartz-shear stability & precision, CE compliant

Applications
Precision measurements on small, thin-walled structures or where space is limited, ideal for high frequency vibration measurements

Accessories
Cable: Type 1761B...
Coupler: Type 5100 series
Datasheet 8728A_000-247

Vibration

Voltage Output, Piezotron Accelerometer

K-Shear Miniature Accelerometer Type 8730A...

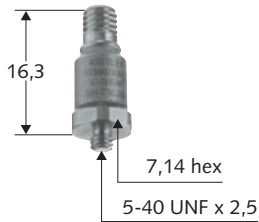

Specifications		Type	Type
		8730A500	8730A500M1
Range	g	±500	±500
Sensitivity, ±10%	mV/g	10	10
Frequency Response, ±5%	Hz	2 ... 10 k	2 ... 7 k
Threshold	g_{rms}	0,02	0,02
Transverse Sensitivity typ.	%	1,5	1,5
Non-Linearity	%FSO	±1	±1
Shock (1 ms pulse)	g	5 000	5 000
Temp. Coeff. of Sensitivity	%/°C	-0,06	-0,06
Operating Temperature	°C	-54 ... 120	-54 ... 120
Power Supply	mA	2 ... 18	2 ... 18
	VDC	20 ... 30	20 ... 30
Housing/Base	type	Titanium	Titanium
Sealing	type	Hermetic	Hermetic
Ground Isolation	MΩ	-	100
Mass	gram	1,9	2,5

Measuring direction Connection
10-32 neg.

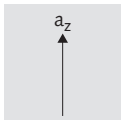

Characteristics
Quartz-shear sensing element, low impedance output, ultra low base strain sensitivity, minimal thermal transient response, CE compliant
Metric Thread available (AE)

Applications
Precision measurements on small, thin-walled structures

Accessories
Cable: Type 1761B...
Coupler: Type 5100 series

Datasheet 8730A_000-248

K-Shear Micro Accelerometer Type 8732A..., 8734A...

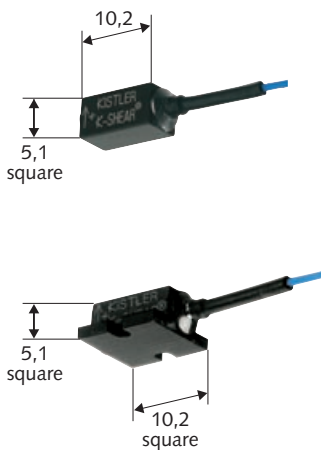

Specifications		Type	Type
		8732A500	8734A500
Range	g	±500	±500
Sensitivity, ±5%	mV/g	10	10
Frequency Response, ±5%	Hz	2 ... 10 k	2 ... 10 k
Threshold	g_{rms}	0,01	0,01
Transverse Sensitivity typ.	%	1,5	1,5
Non-Linearity	%FSO	±1	±1
Shock (1 ms pulse)	g	5 000	5 000
Temp. Coeff. of Sensitivity	%/°C	-0,06	-0,06
Operating Temperature	°C	-54 ... 120	-54 ... 120
Power Supply	mA	2 ... 18	2 ... 18
	VDC	20 ... 30	20 ... 30
Housing/Base	type	Al./Titanium	
Sealing	type	Epoxy	Epoxy
Ground Isolation	MΩ	10	10
Mass	gram	1,1	1,3

Measuring direction Connection
10-32 neg.

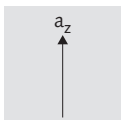

Characteristics
Low impedance voltage mode, quartz-shear element, low profile and lightweight, standard automotive footprint and mounting, CE compliant

Applications
Precision vibration measurement or modal analysis on small, thin-walled structures where space is limited

Accessories
Cable: Type 1761B...
Coupler: Type 5100 series

Datasheet 8732A_000-249

Vibration

Voltage Output, Piezotron Accelerometer

K-Shear Shock Accelerometer Type 8742A...

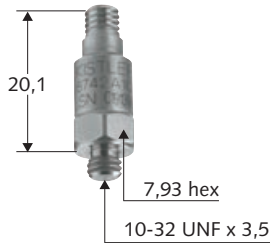

Specifications		Type	Type	Type
		8742A5	8742A10	8742A20
Range	g	±5 k	±10 k	±20 k
Sensitivity, ±5 %	mV/g	1	0,5	0,25
Frequency Response, ±7 %	Hz	1 ... 10 k	1 ... 10 k	1 ... 10 k
Threshold	g_{rms}	0,13	0,25	0,50
Transverse Sensitivity typ.	%	1,5	1,5	1,5
Non-Linearity	%FSO	±1	±1	±1
Shock (1 ms pulse)	g	50 k	50 k	50 k
Temp. Coeff. of Sensitivity	%/°C	-0,06	-0,06	-0,06
Operating Temperature	°C	-54 ... 120	-54 ... 120	-54 ... 120
Power Supply	mA	2 ... 20	2 ... 20	2 ... 20
	VDC	18 ... 30	18 ... 30	18 ... 30
Housing/Base	type	St. Stl.	St. Stl.	St. Stl.
Sealing	type	Hermetic	Hermetic	Hermetic
Mass	gram	4,5	4,5	4,5

Measuring direction Connection
10-32 neg.

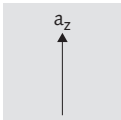

Characteristics
Low impedance voltage mode, unique quartz-shear sensing element, low transverse sensitivity, wide bandwidth, high resonant frequency, CE compliant

Applications
Impact and vibration related applications including shock and vehicle testing

Accessories
Cable: Type 1761B...
Coupler: Type 5100 series

Datasheet 8742A_000-250

K-Shear Shock Accelerometer Type 8742A...

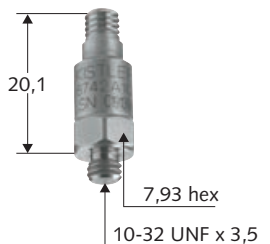

Specifications		Type
		8742A50
Range	g	±50 k
Sensitivity, ±5 %	mV/g	0,10
Frequency Response, ±7 %	Hz	1 ... 10 k
Threshold	g_{rms}	1,30
Transverse Sensitivity typ.	%	1,5
Non-Linearity	%FSO	±1
Shock (1 ms pulse)	g	100 k
Temp. Coeff. of Sensitivity	%/°C	-0,06
Operating Temperature	°C	-54 ... 120
Power Supply	mA	2 ... 20
	VDC	18 ... 30
Housing/Base	type	St. Stl.
Sealing	type	Hermetic
Mass	gram	4,5

Measuring direction Connection
10-32 neg.

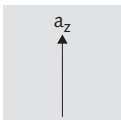

Characteristics
Low impedance voltage mode, unique quartz-shear sensing element, low transverse sensitivity, wide bandwidth, high resonant frequency, CE compliant

Applications
Impact and vibration related applications including shock and vehicle testing

Accessories
Cable: Type 1761B...
Coupler: Type 5100 series

Datasheet 8742A_000-250

Vibration

Voltage Output, Piezotron Accelerometer

K-Shear Shock Accelerometer Type 8743A...

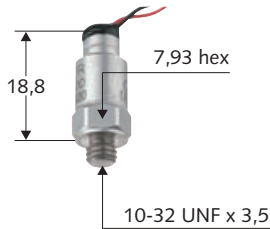

Specifications	Type 8743A100	
Range	g	±100 k
Sensitivity, ±5 %	mV/g	0,05
Frequency Response, ±7 %	Hz	0,5 ... 10 k
Threshold	g_{rms}	2,6
Transverse Sensitivity typ.	%	1,5
Non-Linearity	%FSO	±1
Shock (1 ms pulse)	g	120 k
Temp. Coeff. of Sensitivity	%/°C	-0,06
Operating Temperature	°C	-54 ... 120
Power Supply	mA	2 ... 20
	VDC	18 ... 30
Housing/Base	type	St. Stl.
Sealing	type	Hermetic
Mass	gram	4,5

Measuring direction Connection
10-32 neg.

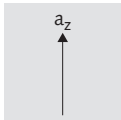

Characteristics
Low impedance, voltage mode, unique quartz sensing element, low transverse sensitivity, wide bandwidth, high resonant frequency, CE compliant

Applications
Impact and vibration related applications including shock and vehicle testing

Accessories
Cable: Type 1761B...
Coupler: Type 5100 series

Datasheet 8742A_000-250

K-Shear Industrial Accelerometer Type 8752A...



Specifications	Type 8752A50	Type 8752A50M5
Range	g	±50
Sensitivity	mV/g	100 (±5%)
Frequency Response	Hz	0,5 ... 5 k (±5%)
Threshold	g_{rms}	0,002
Transverse Sensitivity typ.	%	1,5
Non-Linearity	%FSO	±1
Shock (1 ms pulse)	g	2 000
Temp. Coeff. of Sensitivity	%/°C	-0,03
Operating Temperature	°C	-54 ... 120
Power Supply	mA	2 ... 18
	VDC	20 ... 30
Housing/Base	type	St. Stl.
Sealing	type	Hermetic
Ground Isolation	MΩ	10
Mass	gram	115

Measuring direction Connection
2-pin MIL-C-5015

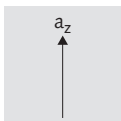

Characteristics
Low impedance voltage mode, quartz-shear stability & precision, insensitive to thermal transients, case and ground isolated, CE compliant

Applications
Industrial applications for machinery monitoring, predictive maintenance and analysis of gears and anti-friction bearings

Accessories
Cable: Type 1770A..., 1772A..., 1776A..., 1778A...
Coupler: Type 5100 series

Datasheet 8752A_000-251

Vibration

Voltage Output, Piezotron Accelerometer

Ceramic Shear Accelerometer Type 8772A...



Specifications		Type	Type	Type
		8772A5	8772A10	8772A50
Range	g	±5	±10	±50
Sensitivity, ±5 %	mV/g	1000	500	100
Frequency Response, ±5 %	Hz	1 ... 5 k	1 ... 5 k	1 ... 5 k
Threshold	μg_{rms}	400	500	2 000
Transverse Sensitivity	%	<5	<5	<5
Non-Linearity	%FSO	±1	±1	±1
Shock (0,2 ms pulse)	g	5 000	7 000	7 000
Temp. Coeff. of Sensitivity	%/°C	-0,15	-0,10	-0,10
Operating Temperature	°C	0 ... 65	0 ... 65	0 ... 65
Power Supply	mA	2 ... 18	2 ... 18	2 ... 18
	VDC	20 ... 30	20 ... 30	20 ... 30
Housing/Base	type	Al., hard anodized		
Sealing	type	Epoxy	Epoxy	Epoxy
Ground Isolation	MΩ	10	10	10
Mass	gram	8	8	8
Mounting	type	Adhesive/wax	Adhesive/wax	Adhesive/wax

Measuring direction a_z
 Connection 10-32 neg.

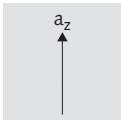

Characteristics
 Low impedance voltage mode, lightweight, ceramic shear sensing element, cube shaped for mounting flexibility, CE compliant
 T: TEDS option available

Applications
 Modal analysis applications exposed to environmental factors

Accessories
 Cable: Type 1761B...
 Coupler: Type 5100 series
 Mounting clip: Type 8474

Datasheet 8772A_000-253

Ceramic Shear Accelerometer Type 8774A..., 8776A...

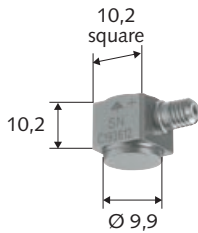

Specifications		Type	Type	Type
		8774A50	8776A50M1	8776A50M6
Range	g	±50	±50	±50
Sensitivity, -5 ... 30 %	mV/g	100	100	100
Frequency Response, ±5 %	Hz	1 ... 10 k	1 ... 7 k	1 ... 10 k
Threshold	g_{rms}	0,0025	0,0025	0,0025
Transverse Sensitivity typ.	%	1,5	1,5	1,5
Non-Linearity	%FSO	±0,5	±1	±1
Shock (0,2 ms pulse)	g	5 000	5 000	5 000
Temp. Coeff. of Sensitivity	%/°C	-0,14	-0,14	-0,14
Operating Temperature	°C	-54 ... 121	-54 ... 121	-54 ... 121
Power Supply	mA	2 ... 20	2 ... 20	2 ... 20
	VDC	18 ... 30	18 ... 30	18 ... 30
Housing/Base	type	Titanium	Titanium	Titanium
Sealing	type	Hermetic	Hermetic	Hermetic
Ground Isolation	MΩ	-	10	-
Mass	gram	4,0	4,3	4,5

Measuring direction a_z
 Connection 10-32 neg.
 Side connector: 8776
 Top connector: 8774

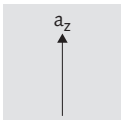

Characteristics
 Low impedance voltage mode, high sensitivity, high resolution ceramic, shear sensing element, rugged connector, priced for OEM applications, CE compliant

Applications
 Modal analysis where environmental changes or temperature transient are prevalent

Accessories
 Cable: Type 1761B...
 Coupler: Type 5100 series

Datasheet 8774A_000-255

Vibration

Voltage Output, Piezotron Rotational Accelerometer

Ceramic Shear Accelerometer Type 8776A...

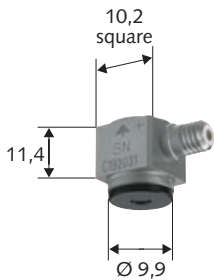

Specifications	Type 8776A50M3	
Range	g	±50
Sensitivity, ±5 %	mV/g	100
Frequency Response, ±5 %	Hz	0,5 ... 4 k
Threshold	g_{rms}	0,003
Transverse Sensitivity typ.	%	3
Non-Linearity	%FSO	±1
Shock (1 ms pulse)	g	5 000
Temp. Coeff. of Sensitivity	%/°C	-0,14
Operating Temperature	°C	-54 ... 120
Power Supply	mA	2 ... 20
	VDC	18 ... 30
Housing/Base	type	Titanium
Sealing	type	Hermetic
Ground Isolation	MΩ	10
Mass	gram	4,3
Mounting	type	Adhesive/wax

Measuring direction Connection
10-32 neg.

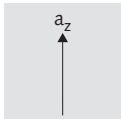

Characteristics
High sensitivity, high resolution, economical pricing

Applications
Low level vibration and where wide bandwidth and rugged construction are required

Accessories
Cable: Type 1761B...
Coupler: Type 5100 series

Datasheet 8774_000-255

Voltage Output, Piezotron Accelerometer

Ceramic Shear Miniature Accelerometer Type 8778A...

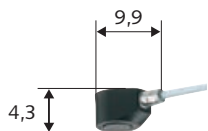

Specifications	Type 8778A500	
Range	g	±500
Sensitivity, ±5 %	mV/g	10
Frequency Response, ±5 %	Hz	2 ... 9 k
Threshold	g_{rms}	0,01
Transverse Sensitivity typ.	%	3
Non-Linearity	%FSO	±1
Shock (1 ms pulse)	g	5 000
Temp. Coeff. of Sensitivity	%/°C	-0,14
Operating Temperature	°C	-54 ... 121
Power Supply	mA	2 ... 20
	VDC	18 ... 30
Housing/Base	type	Titanium/Hard Anod. Aluminium
Sealing	type	Epoxy
Mass	gram	0,29
Ground Isolation	MΩ	10

Measuring direction Connection
10-32 neg.

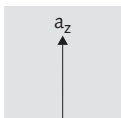

Characteristics
Low impedance voltage mode, ultra low base strain and thermal transient response, ground isolated assembly, high 10 mV/g sensitivity, CE compliant
M14: version available (repairable twisted pair cable)

Applications
Precision vibration measurement, modal analysis on small, thin walled structures or where space is limited and mass loading is of primary concern

Accessories
Cable: Type 1761B...
Coupler: Type 5100 series
Removal Tool: Type 1378
Twisted pair replacement cable

Datasheet 8778A_000-256

Vibration

Voltage Output, Piezotron Accelerometer

Ceramic Shear Accelerometer Type 8784A..., 8786A...

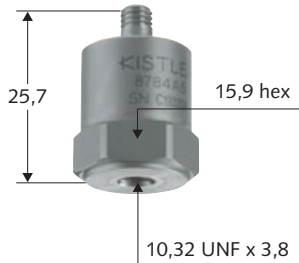

Specifications		Type	Type
		8784A5	8786A5
Range	g	±5	±5
Sensitivity, ±5 %	mV/g	1000	1000
Frequency Response, ±5 %	Hz	1 ... 6 k	1 ... 6 k
Threshold	g_{rms}	0,0004	0,0004
Transverse Sensitivity typ.	%	1,5	1,5
Non-Linearity	%FSO	±1	±1
Shock (1 ms pulse)	g	2 500	2 500
Temp. Coeff. of Sensitivity	%/°C	-0,06	-0,06
Operating Temperature	°C	-54 ... 80	-54 ... 80
Power Supply	mA	2 ... 20	2 ... 20
	VDC	18 ... 30	18 ... 30
Housing/Base	type	Titanium	Titanium
Sealing	type	Hermetic	Hermetic
Mass	gram	21	21

Measuring direction

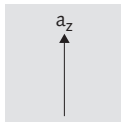

Connection

10-32 neg.
Side connector:
8786

Characteristics

Ceramic shear sensing element, low impedance, voltage mode, high sensitivity, less than 1 mg resolution, rugged connector for repeated connections, priced for OEM, CE compliant

Application

Low impact and vibration related applications including condition monitoring and vehicle testing

Accessories

Cable: Type 1761B...
Coupler: Type 5100 series

Datasheet 8784A_000-257

Voltage Output, Piezotron Rotational Accelerometer

K-Shear Axial/Lateral Rotational Accelerometer Type 8838, 8840

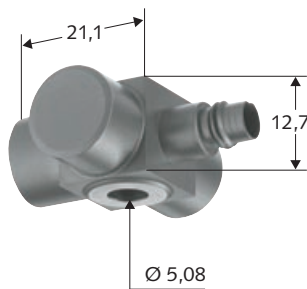

Specifications		Type	Type
		8838	8840
Range	krads/s ²	±150	±150
Sensitivity	µV/rad/s ²	34	34
Frequency Response	Hz	1 ... 2 k	1 ... 2 k
Threshold noise	rad/s ²	4	4
Transverse Sensitivity typ.	%	1,5	1,5
Non-Linearity	%FSO	±1	±1
Shock (1 ms pulse)	g	5 000	5 000
Temp. Coeff. of Sensitivity	%/°C	-0,06	-0,06
Operating Temperature	°C	-54 ... 121	-54 ... 121
Power Supply	mA	4	4
	VDC	20 ... 30	20 ... 30
Housing/Base	type	Titanium	Titanium
Sealing	type	Hermetic	Hermetic
Ground Isolation	MΩ	10	10
Mass	gram	18,5	18,5
Mounting	type	Cap screw	Cap screw M5 x 20

Axial
Measuring direction
8838

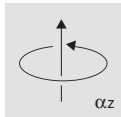

Lateral
Measuring direction
8840

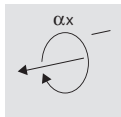

Connection

4-pin Microtech
pos.

Characteristics

Shear quartz piezoelectric, principal, axial or lateral oscillations, hermetic construction, lightweight and convenient thru hole mount, CE compliant

Applications

Axial or shaft type measurements on an oscillating but non-rotating specimen (8838), plate or lateral rotational acceleration measurements with type 8840

Accessories

Cable: Type 1592M1..., 1578A, 1786C...

Datasheet 8838_000-271

Acoustic Emission

Acoustic Emission (AE) are transient elastic waves during the rapid release of energy from localized sources within a material. AE waves range in frequency from a few kHz to several MHz.

The source of these emissions in metals is closely associated with the dislocation movements accompanying plastic deformation and the initiation and extension of cracks in a structure under stress. Sources of AE include melting, phase transformation, thermal stresses, cool down cracking, friction mechanisms and stress build up.

The AE sensor can be used to monitor processes such as:

- Stamping
- Deep Drawing
- Cutting Tool Breakage
- Fracture of metal or composite pressure vessels
- Fracture of stressed structures/ bridges
- Detecting loose parts in an electronic assembly
- Detecting, locating and evaluating flaws in materials
- Insect activity in wood
- Steam Valve leaks
- Partial discharge in transformers

AE sensors can warn of faults when they are occurring, not just whether or not they exist like traditional non-destructive test methods, i.e. x-ray, dye penetrants, eddy current, ultrasonic transmission or microscopic inspection. Detectable AE signals are emitted before visual signs of fracture or cracking appear.



Acoustic Emission

Voltage Output, Piezotron Acoustic Emission Sensor

Piezotron Ceramic Shear Acoustic Emission Sensor Type 8152B...

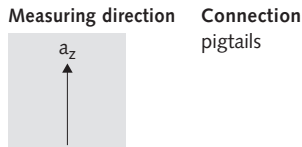
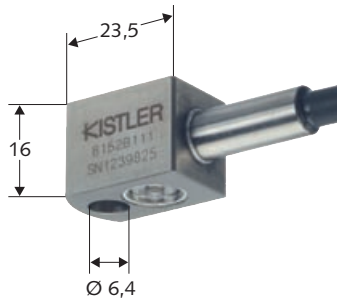

Specifications		Type	Type
		8152B1	8152B2
Frequency range, ± 10 dB	kHz	50...400	100...900
Sensitivity (nom.)	$\text{dB}_{\text{ref } 1\text{V (m/s)}}$	57	48
Overload Shock 0,5 ms pulse	g	2 000	2 000
Overload vibration	g	± 1000	± 1000
Operating temperature range	$^{\circ}\text{C}$	-40...60	-40...60
Supply: Constant current	mA	3...6	3...6
Voltage (coupler)	V DC	5...36	5...36
Output: Voltage (full scale)	V	± 2	± 2
Output bias	V DC	2,5	2,5
Mass	gram	29	29
Case material		St. Stl.	St. Stl.
Sealing	type	Hermetic	Hermetic
Ground Isolation	Ω	≥ 1	≥ 1

Characteristics

High sensitivity and wide frequency range, inherent high-pass-characteristic, robust, suitable for industrial use (Degree of protection IP 65 resp. IP 67), ground isolated, CE compliant

Applications

Measurement of very high frequency phenomena particularly on machine structures. Crack formation investigations, fatigue studies and machine tool diagnostics

Accessories

Magnetic clamp: Type 8443B
AE Coupler: Type 5125B...

Data sheet 8152B_000-204

Triaxial

The PiezoBeam, Ceramic Shear, K-Shear and K-Beam technologies have been packaged into triaxial assemblies providing a convenient means to obtain three orthogonal data sets from a single sensor. The integral package is less cost than three separate accelerometers mounted to a common center and typically easier to set-up and operate due to mounting and cabling considerations.



Triaxial

Capacitive Accelerometer

K-Beam Capacitive Triaxial Accelerometer Type 8393A...

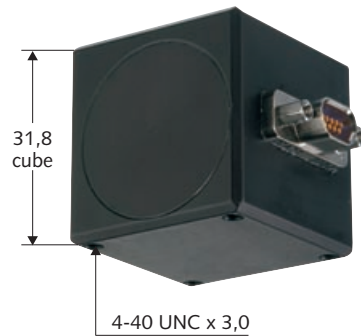

Specifications		Type	Type
		8393A2	8393A10
Range	g	±2	±10
Sensitivity, ±5 %	mV/g	1000	200
Output at Zero g, ±30 mV	V	0	0
Frequency Response, ±5 %	Hz	0 ... 250	0 ... 180
Non-Linearity	%FSO	±0,8	±0,8
Resolution/Threshold	µg	540	2830
Transverse Sensitivity typ.	%	1	1
Shock (700 µs half sine)	g	6000	6000
Temp. Coeff.: Bias typ.	mg/°C	0,2	1
Sensitivity typ.	%/°C	0,02	0,02
Phase Shift max. @ 100 Hz	deg.	20	20
Operating Temperature	°C	-40 ... 85	-40 ... 85
Power Supply	mA	4	4
	VDC	3,8 ... 16	3,8 ... 16
Housing/Base	type	Al., hard anodized	
Sealing	type	Epoxy	
Ground Isolation	MΩ	10	10
Mass	gram	60	60

Measuring direction

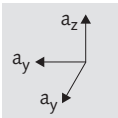

Connection

9-pin micro D pos.

Characteristics

Excellent thermal performance, operates from 3,8 to 16 VDC, CE compliant

Applications

Structural dynamics for bridges and buildings; transportation, robotics, human motion and seismic ground measurements

Accessories

Cable: Type 1792A2
cap screw 4-40 UNC x 0,19"

Datasheet 8393A_000-224

Charge Output, Extreme Temperature

Ceramic Shear Triaxial Accelerometer Type 8290A...

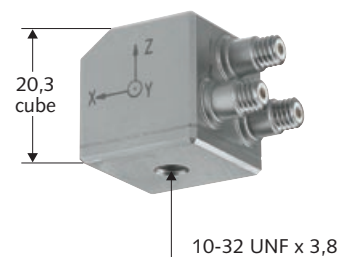

Specifications		Type
		8290A25M5
Range	g	±1000
Sensitivity, ±15 %	pC/g	-25
Frequency Response:		
stud mounted ±10 %	Hz	5 ... 4 k
Transverse Sensitivity typ.	%	1,5
Non-Linearity	%FSO	±1
Shock (1 ms pulse)	g	5000
Temp. Coeff. of Sensitivity	%/°C	0,13
Operating Temperature	°C	-70 ... 250
Housing/Base	type	St. Stl.
Sealing	type	Hermetic
Mass	gram	53

Measuring direction

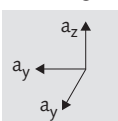

Connection

Type 10-32 neg.

Characteristics

High impedance, charge mode
Ceramic Shear sensing element,
low transverse sensitivity,
long-term stability at extended
temperatures

Applications

General vibration measurements
with varying test conditions,
vehicle vibration and NVH test-
ing, general laboratory and ESS

Accessories

Mounting stud:
Type 8402, 8411 (only supplied
outside N.A.)
Charge amplifier: Type 5000 series
Cable: Type 1631C...

Datasheet 8290A_000-215

Triaxial

Voltage Output, Piezotron Accelerometer

PiezoBeam Triaxial Accelerometer Type 8690C...

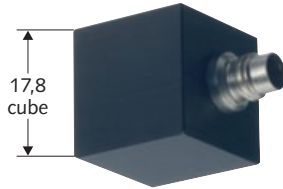

Specifications		Type 8690C5	Type 8690C10	Type 8690C50
Range	g	±5	±10	±50
Sensitivity, ±5 %	mV/g	1000	500	100
Frequency Response, ±5 %	Hz	1 ... 3 k	1 ... 5 k	1 ... 6 k
Threshold	μg_{rms}	120	280	1000
Transverse Sensitivity	%	<1	<1	<1
Non-Linearity	%FSO	±1	±1	±1
Shock (0,2 ms pulse)	g	5 000	10 000	10 000
Temp. Coeff. of Sensitivity	%/°C	-0,04	0,08	0,08
Operating Temperature	°C	0 ... 65	0 ... 65	0 ... 65
Power Supply	mA	2 ... 18	2 ... 18	2 ... 18
	VDC	20 ... 30	20 ... 30	20 ... 30
Housing/Base	type	Al., hard anodized		
Sealing	type	Epoxy	Epoxy	Epoxy
Ground Isolation	MΩ	10	10	10
Mass	gram	11,2	11,2	11,2

Measuring direction Connection
4-pin pos.

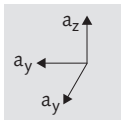

Characteristics
Low impedance voltage mode, high sensitivity small, cubic design, thermal stability, CE compliant
T: TEDS option available

Applications
Modal analysis or structural testing

Accessories
Cable: Type 1756B..., 1578A...
Coupler: Type 5100 series
Mounting clip: Type 8476

Datasheet 8690C_000-234

PiezoBeam Triaxial Accelerometer Type 8692C...



Specifications		Type 8692C5	Type 8692C10	Type 8692C50
Range	g	±5	±10	±50
Sensitivity, ±5 %	mV/g	1000	500	100
Frequency Response, ±5 %	Hz	1 ... 3 k	1 ... 5 k	1 ... 6 k
Threshold	μg_{rms}	120	280	1000
Transverse Sensitivity	%	<1	<1	<1
Non-Linearity	%FSO	±1	±1	±1
Shock (0,2 ms pulse)	g	5 000	10 000	10 000
Temp. Coeff. of Sensitivity	%/°C	-0,04	0,08	0,08
Operating Temperature	°C	0 ... 65	0 ... 65	0 ... 65
Power Supply	mA	2 ... 18	2 ... 18	2 ... 18
	VDC	20 ... 30	20 ... 30	20 ... 30
Housing/Base	type	Al., hard anodized		
Sealing	type	Epoxy	Epoxy	Epoxy
Ground Isolation	MΩ	10	10	10
Mass	gram	16	16	16
Mounting	type	Magnetic	Magnetic	Magnetic

Measuring direction Connection
4-pin pos.

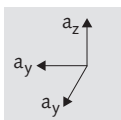

Characteristics
Low impedance voltage mode, high sensitivity, thermal stability, CE compliant
M1: 10-32 mounting hole option available

Applications
Modal analysis or structural testing

Accessories
Cable: Type 1756B...
Extension cable: Type 1578A...
Coupler: Type 5100 series

Datasheet 8692C_000-236

Triaxial

Voltage Output, Piezotron Accelerometer

Piezotron Miniature Quartz Compression Accelerometer Type 8694...

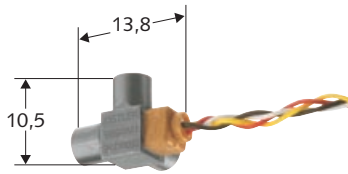

Specifications	Type 8694M1	
Range	g	±500
Sensitivity nom.	mV/g	4
Frequency Response, ±5%	Hz	10 ... 20 k
Threshold	g_{rms}	0,025
Transverse Sensitivity	%	5
Non-Linearity	%FSO	±1
Shock (1 ms pulse width) max.	g_{pk}	±2 000
Temp. Coeff. of Sensitivity	%/°C	-0,06
Operating Temperature	°C	-55 ... 135
Power Supply	mA	4
	VDC	12 ... 30
Housing/Base	type	Titanium
Sealing – Housing/Connector	type	Epoxy
Mass	gram	2,5

Measuring direction Connection
4-pin neg.

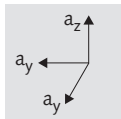

Characteristics
Low impedance voltage mode, small size and lightweight, less than 2,5 grams, very high resonant frequency, CE compliant

Applications
Dynamic characteristics of very light test objects, measuring of vibrations on thin-walled structures, modal testing

Accessories
Anodized adaptor: Types 8439, 8440 for ground isolation
Cable: Type 1578A..., 1576...
Coupler: Type 5100 series

Datasheet 8694M_000-237

Annular Ceramic Shear Triaxial Accelerometer Type 8762A...

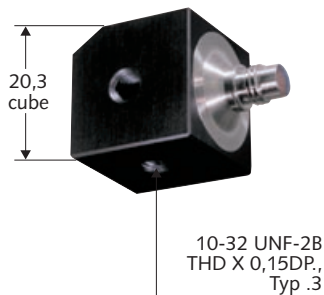

Specifications		Type 8762A5	Type 8762A10	Type 8762A50
		Range	g	±5
Sensitivity, ±5%	mV/g	1000	500	100
Frequency Response, ±5%	Hz	0,5 ... 6 000	0,5 ... 6 000	0,5 ... 6 000
Threshold	g_{rms}	0,0003	0,00035	0,0012
Transverse Sensitivity typ.	%	≤5	≤5	≤5
Non-Linearity	%FSO	±1	±1	±1
Shock (0,2 ms pulse) max.	g_{pk}	5 000	7 000	7 000
Temp. Coeff. of Sensitivity	%/°C	-0,06	-0,02	-0,02
Operating Temperature	°C	-54 ... 80	-54 ... 80	-54 ... 80
Power Supply	mA	2 ... 18	2 ... 18	2 ... 18
	VDC	20 ... 30	20 ... 30	20 ... 30
Housing/Base	type	Al./hard anodized		
Sealing	type	Epoxy	Epoxy	Epoxy
Ground Isolation	MΩ	10	10	10
Mass	gram	23	23	23

Measuring direction Connection
4-pin pos.

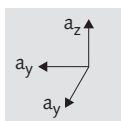

Characteristics
Cubed triaxial, (3) 10-32thd. mounting holes, low thermal transient response, durable hard anodized Al. housing, gnd. isolated
T: TEDS option available

Applications
Modal analysis, automotive bodies and aircraft structures, general vibrations

Accessories
Cable: Type 1756B...
Extension Cable: Type 1578A
Coupler: Type 5100 series

Datasheet 8762A_000-456

Triaxial

Voltage Output, Piezotron Accelerometer

Ceramic Shear Triaxial Accelerometer Type 8763A...

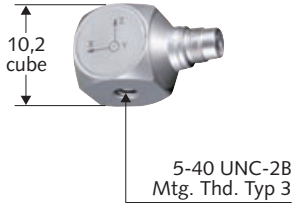

Specifications		Type 8763A500
Range	g	±500
Sensitivity, ±10%	mV/g	10
Frequency Response, ±5%	Hz	1 ... 12 000
Threshold	g_{rms}	0,018
Transverse Sensitivity typ.	%	2,5
Non-Linearity	%FSO	±1
Shock (1 ms pulse width) max.	g_{pk}	5 000
Temp. Coeff. of Sensitivity	%/°C	-0,14
Operating Temperature	°C	-54 ... 121
Power Supply	mA	2 ... 20
	VDC	18 ... 30
Housing/Base	type	Titanium
Sealing	type	Hermetic
Mass	gram	3,3

Measuring direction

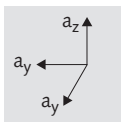

Connection

Mini 4-pin pos.

Characteristics

Mini cube design, (3) 5-40 thread holes, light weight, mini 4-pin connector, low base strain sensitivity, CE Compliant

Applications

Dynamic vibration, shock measurement, light weight structures

Accessories

Cable: Type 1784A(K)03
Coupler: Type 5100 series

Datasheet 8763A_000-474

Triaxial

Voltage Output, Piezotron Accelerometer

PiezoStar Miniature Triaxial Shear Accelerometer Type 8765A...

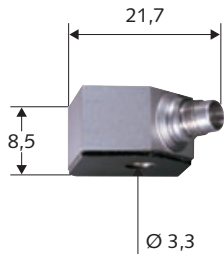

Specifications		Type 8765A250M5
Range	g	±250
Sensitivity, ±10%	mV/g	20
Frequency Response, ±5%	Hz	1 ... 9 000
Threshold	g_{rms}	0,002
Transverse Sensitivity typ.	%	2,5
Non-Linearity	%FSO	±1
Shock (1 ms pulse width) max.	g_{pk}	5 000
Temp. Coeff. of Sensitivity	%/°C	-0,008
Operating Temperature	°C	-54 ... 165
Power Supply	mA	2 ... 20
	VDC	18 ... 30
Housing/Base	type	Titanium
Sealing	type	Hermetic
Ground Isolation	MΩ	10
Mass	gram	6,4

Measuring direction **Connection**
Mini 4-pin pos.

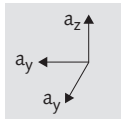

Characteristics
Super low thermal transient sensitivity, high temp, hermetic sealing, low base strain, mini 4-pin connector, and PiezoStar material

Applications
Modal analysis, automotive bodies and aircraft structures, general vibrations

Accessories
Insulated mounting screw M2,5 x 12
Cable: Type 1784A...K03
Coupler: Type 5100 series

Datasheet 8765A_000-472

K-Shear Miniature Triaxial Accelerometer Type 8791A...

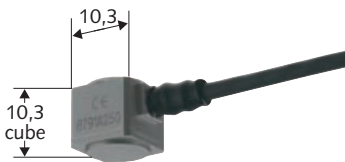

Specifications		Type 8791A250	
Range	g	±250	
Sensitivity, ±15%	mV/g	20	
Frequency Response,	±5%, adhesive mount	Hz	2 ... 2 k
	±10%, adhesive mount	Hz	1 ... 4,5 k
Threshold	g_{rms}	0,006	
Transverse Sensitivity typ.	%	1,5	
Non-Linearity	%FSO	±1	
Shock (1 ms pulse)	g	3 000	
Temp. Coeff. of Sensitivity	%/°C	-0,06	
Operating Temperature	°C	-55 ... 120	
Power Supply	mA	2 ... 20	
	VDC	18 ... 30	
Housing/Base	type	Titanium	
Sealing – Housing/Connector	type	Epoxy	
Mass without cable	gram	4	

Measuring direction **Connection**
4-pin pos.

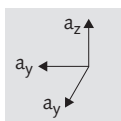

Characteristics
Quartz shear sensing elements, high immunity to thermal transients, ultra-low base strain sensitivity, CE compliant

Applications
The extremely low mass is highly attractive where mass loading of specimens is a concern

Accessories
Mounting wax: Type 8432
Cable: Type 1578A..., 1756B...
Coupler: Type 5100 series

Datasheet 8791A_000-259

Triaxial

Voltage Output, Piezotron Accelerometer

K-Shear Triaxial Accelerometer Type 8792A...

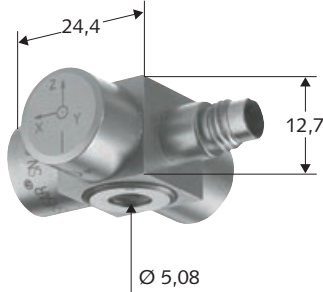

Specifications		Type	Type	Type
		8792A25	8792A50	8792A100
Range	g	±25	±50	±100
Sensitivity, ±5 %	mV/g	200	100	50
Frequency Response, ±5 %	Hz	1,0 ... 5 k	0,5 ... 5 k	0,5 ... 5 k
Threshold	g_{rms}	0,002	0,004	0,006
Transverse Sensitivity typ.	%	1,5	1,5	1,5
Non-Linearity	%FSO	±1	±1	±1
Shock (1 ms pulse) max.	g	2 000	2 000	2 000
Temp. Coeff. of Sensitivity	%/°C	-0,06	-0,06	-0,06
Operating Temperature	°C	-55 ... 100	-55 ... 100	-55 ... 100
Power Supply	mA	2 ... 18	2 ... 18	2 ... 18
	VDC	20 ... 30	20 ... 30	20 ... 30
Housing/Base	type	St. Stl.	St. Stl.	St. Stl.
Sealing	type	Hermetic	Hermetic	Hermetic
Ground Isolation	MΩ	10	10	10
Mass	gram	29	29	29

Measuring direction Connection
4-pin pos.

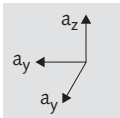

Characteristics
High immunity to thermal transients, ultra-low base strain sensitivity, wide frequency range, ground isolated, low profile design, CE compliant
T: TEDS option available

Applications
Center hole mounting capability allows orientation of exit cable or axis alignment. The low profile package accommodates restricted space environments

Accessories
Socket cap head screw, 10-32 x 0,75" and M5 x 20 mm
Cable: Type 1578A..., 1756B...
Coupler: Type 5100 series

Datasheet 8792A_000-260

K-Shear Triaxial Accelerometer Type 8792A...

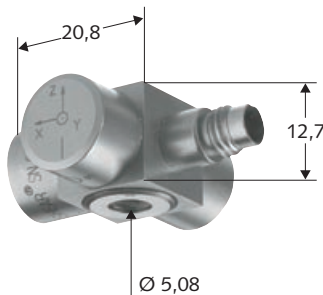

Specifications		Type
		8792A500
Range	g	±500
Sensitivity, ±5 %	mV/g	10
Frequency Response, -5, + 10 %	Hz	1 ... 5 000
Threshold	g_{rms}	0,01
Transverse Sensitivity typ.	%	1,5
Non-Linearity	%FSO	±1
Shock (1 ms pulse) max.	g	5 000
Temp. Coeff. of Sensitivity	%/°C	-0,06
Operating Temperature	°C	-55 ... 100
Power Supply	mA	2 ... 18
	VDC	20 ... 30
Housing/Base	type	St. Stl.
Sealing	type	Hermetic
Ground Isolation	MΩ	10
Mass	gram	29

Measuring direction Connection
4-pin pos.

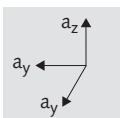

Characteristics
High immunity to thermal transients, ultra-low base strain sensitivity, wide frequency range, ground isolated, low profile design, CE compliant

Applications
Center hole mounting capability allows orientation of exit cable or axis alignment. The low profile package accommodates restricted space environments

Accessories
Socket cap head screw, 10-32 x 0,75" and M5 x 20 mm
Cable: Type 1578A..., 1756B...
Coupler: Type 5100 series

Datasheet 8792A_000-260

Triaxial

Voltage Output, Piezotron Accelerometer

K-Shear Triaxial Accelerometer Type 8793A...

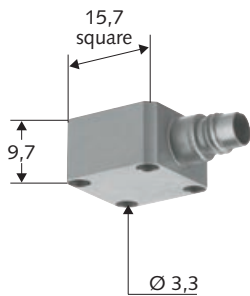

Specifications		Type	Type	Type
		8793A500	8793A500M5	8793A500M8
Range	g	±500	±500	±500
Sensitivity	mV/g	10	10	10
Frequency Response, ±5%	Hz	2,5 ... 10 k	2,5 ... 10 k	2,5 ... 10 k
Threshold	g_{rms}	0,002	0,002	0,002
Transverse Sensitivity typ.	%	1,5	1,5	1,5
Non-Linearity	%FSO	±1	±1	±1
Shock (1 ms pulse) max.	g	5 000	5 000	5 000
Temp. Coeff. of Sensitivity	%/°C	-0,03	-0,03	-0,03
Operating Temperature	°C	-55 ... 120	-55 ... 165	-195 ... 120
Power Supply	mA	2 ... 18	2 ... 18	2 ... 18
	VDC	20 ... 30	20 ... 30	20 ... 30
Housing/Base	type	St. Stl.	St. Stl.	St. Stl.
Sealing	type	Hermetic	Hermetic	Hermetic
Mass	gram	11	11	11

Measuring direction Connection
4-pin pos.

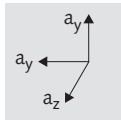

Characteristics
Low impedance voltage mode, low profile design, quartz shear accuracy and stability, hermetically sealed, CE compliant
M3: low frequency 1 Hz option available
T: TEDS option available

Applications
Useful for measuring small and lightweight structures, where mass loading must be kept at a minimum

Accessories
Cap screws 4-40 x 0,5" and M2,5 x 12 mm
Cable: Type 1756B..., 1578A...
Coupler: Type 5100 series

Datasheet 8793A_000-261

K-Shear Triaxial Accelerometer Type 8794A...

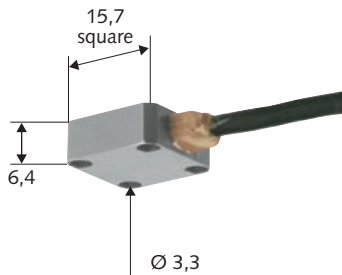

Specifications		Type	Type	Type
		8794A500	8794A500M5	8794A500M3
Range	g	±500	±500	±500
Sensitivity	mV/g	10	10	10
Frequency Response, ±5%	Hz	2,5 ... 10 k	2,5 ... 10 k	1 ... 10 k
Threshold	g_{rms}	0,002	0,002	0,002
Transverse Sensitivity typ.	%	1,5	1,5	1,5
Non-Linearity	%FSO	±1	±1	±1
Shock (1 ms pulse) max.	g	5 000	5 000	5 000
Temp. Coeff. of Sensitivity	%/°C	-0,02	-0,02	-0,02
Operating Temperature	°C	-55 ... 120	-55 ... 165	-55 ... 120
Power Supply	mA	2 ... 18	2 ... 18	2 ... 18
	VDC	20 ... 30	20 ... 30	20 ... 30
Housing/Base	type	St. Stl.	St. Stl.	St. Stl.
Sealing – Housing/Connector	type	Welded/Epoxy	Welded/Epoxy	Welded/Epoxy
Mass	gram	7,6	7,6	9

Measuring direction Connection
4-pin pos.

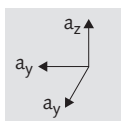

Characteristics
Low impedance voltage mode, low profile design, quartz shear accuracy and stability, CE compliant, ground isolation version available
M3: low frequency 1 Hz option available

Applications
Measurements in confined spaces. The low profile design provides an aerodynamic advantage for in-flight flutter testing

Accessories
Mounting screw 4-40 x 0,375" and M2,5 x 10 mm
Cable: Type 1756B..., 1578A...
Coupler: Type 5100 series

Datasheet 8794A_000-263

Triaxial

Voltage Output, Piezotron Accelerometer

K-Shear Triaxial Cube Accelerometer Type 8795A...

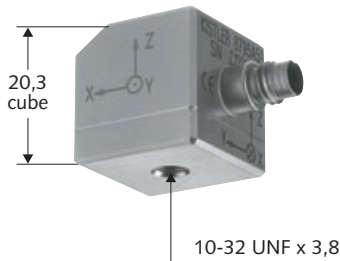

Specifications		Type	Type	Type
		8795A50	8795A50M5	8795A50M8
Range	g	±50	±50	±50
Sensitivity, ±10%	mV/g	100	100	100
Frequency Response, ±5%	Hz	1 ... 4 k	1 ... 4 k	1 ... 4 k
Threshold	g_{rms}	0,001	0,001	0,001
Transverse Sensitivity typ.	%	1,5	1,5	1,5
Non-Linearity	%FSO	±1	±1	±1
Shock (1 ms pulse) max.	g_{pk}	5 000	5 000	5 000
Temp. Coeff. of Sensitivity	%/°C	-0,03	-0,03	-0,03
Operating Temperature	°C	-55 ... 120	-55 ... 165	-195 ... 121
Power Supply	mA	2 ... 18	2 ... 18	2 ... 18
	VDC	20 ... 30	20 ... 30	20 ... 30
Housing/Base	type	Titanium	Titanium	Titanium
Sealing – Housing/Connector	type	Hermetic	Hermetic	Hermetic
Mass	gram	32	32	32

Measuring direction Connection
4-pin pos.

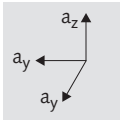

Characteristics
Titanium case, patented
K-Shear design, hermetically
sealed, CE compliant
T: TEDS option available

Applications
Vehicle vibration and noise
harshness (NVH) testing, gener-
al laboratory and modal testing

Accessories
Mounting stud:
Type 8402, 8411
Cable: Type 1578A..., 1756B...
Coupler: Type 5100 series

Datasheet 8795A_000-264

Impulse

A selection of Impulse Hammers is available covering ranges of applications from small to very large mechanical structures. The force-instrumented hammer contains a load cell at the impact end where a variety of tips can be attached. The input power spectrum provided to a test structure can be controlled by appropriate selection of hammer and contact tip. The hammer designs are rugged with the cabling conveniently exiting the rear of the handle. Hammer mass and tip interchanges are accommodated by simple threaded engagement to the hammerhead.



Impulse

Force Sensor

Piezotron Impedance Head Type 8770A...

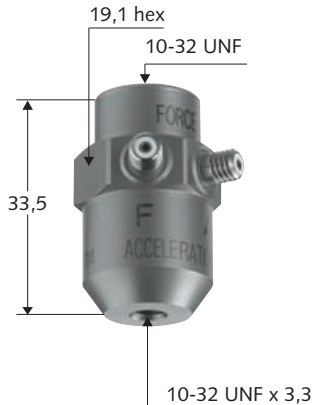

Specifications		Type 8770A5	Type 8770A50
ACCELERATION			
Range	g	±5	±50
Sensitivity, ±10%	mV/g	1000	100
Frequency Response, ±5%	Hz	1 ... 4 k	1 ... 4 k
Threshold	g_{rms}	0,0004	0,001
Transverse Sensitivity typ.	%	1,5	1,5
Temp. Coeff. of Sensitivity	%/°C	0,14	0,14
FORCE			
Range	N	22	222
Sensitivity, ±10%	mV/N	225	22,5
Threshold	N	0,0006	0,006
Temp. Coeff. of Sensitivity	%/°C	0,05	0,05
Operating Temperature	°C	-54 ... 80	-54 ... 121
Power Supply	mA	2 ... 18	2 ... 18
	VDC	20 ... 30	20 ... 30
Housing/Base	type	Titanium	Titanium
Sealing	type	Hermetic	Hermetic
Mass	gram	34	34

Measuring direction Connection
10-32 neg.

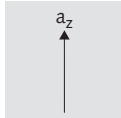

Characteristics
Low impedance voltage mode, sensitivity unaffected by mounting torque wide frequency range, CE compliant

Applications
Modal analysis, typically installed on a test article and connected by a threaded stinger to a shaker. Measures input force and acceleration simultaneously

Accessories
Cable: Type 1761B...
Coupler: Type 5100 series
Datasheet 8770A_000-252

Quartz Compression High Impedance Load Cell Type 9222

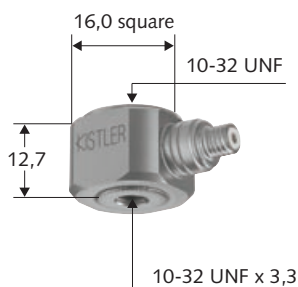

Specifications		Type 9222
Range Compression	N	20 000
Range Tension	N	2 000
Threshold	mN	8,9
Sensitivity (nom.)	pC/N	-84,5
Non-Linearity	%FSO	±0,5
Rigidity	kN/μm	>0,8
Temp. Coeff. of Sensitivity	%/°C	0,036
Operating Temperature	°C	-195 ... 150
Insulation Resistance	Ω	10 ¹³
Capacitance	pF	23
Housing/Base	type	St. Stl.
Sealing	type	Welded/Epoxy
Mass	gram	19

Measuring direction Connection
10-32 neg.

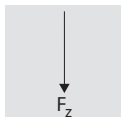

Characteristics
High impedance, charge mode output, rugged quartz sensor, wide measuring ranges for compression and tension, quasi-static response

Applications
Force applications such as press fit assembly, crimping and impact force testing; can be used with shakers for modal analysis, machine tool measurements or various automotive, aerospace and robotic testing

Accessories
Cable: Type 1631A..., 1631C...
Charge amplifier: Type 5000 series
Impact pad: Type 900A1
Datasheet 9212_000-418

Impulse

Voltage Output Force Sensor

Quartz Compression Piezotron Load Cell Type 9712B...

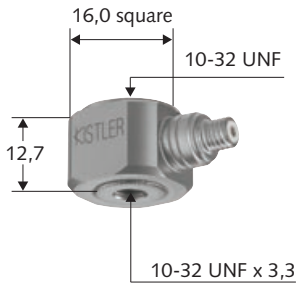

Specifications		Type 9712B5	Type 9712B50	Type 9712B250
Range Compression	N	22,2	222	1,11 kN
Range Tension	N	22,2	222	1,11 kN
Threshold	mN	0,445	4,45	22,2
Sensitivity (nom.)	mV/N	200	20	4
Non-Linearity	%FSO	±1	±1	±1
Rigidity	kN/μm	>0,8	>0,8	>0,8
Temp. Coeff. of Sensitivity	%/°C	-0,018	-0,018	-0,018
Operating Temperature	°C	-50 ... 120	-50 ... 120	-50 ... 120
Power Supply	mA	4	4	4
	VDC	20 ... 32	20 ... 32	20 ... 32
Housing/Base	type	St. Stl.	St. Stl.	St. Stl.
Sealing	type	Hermetic	Hermetic	Hermetic
Mass	gram	19	19	19

Measuring direction Connection
10-32 neg.

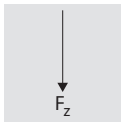

Characteristics
Low impedance voltage mode, rugged quartz sensor, wide measuring range, uses standard low cost cables, CE compliant

Applications
Force applications where high sensitivity, high rigidity and fast responses are required

Accessories
Cable: Type 1761B...
Charge amplifier: Type 5100 series
Impact pad. Type 900A1

Datasheet 9712_000-417

Quartz Piezotron Load Cell Type 9712B...

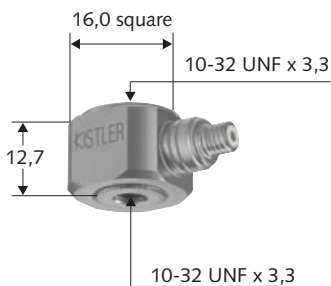

Specifications		Type 9712B500	Type 9712B5000
Range Compression	N	2000	20 000
Range Tension	N	2 000	2 000
Threshold	mN	44,5	445
Sensitivity (nom.)	mV/N	2	0,2
Non-Linearity	%FSO	±1	±1
Rigidity	kN/μm	>0,8	>0,8
Temp. Coeff. of Sensitivity	%/°C	-0,018	-0,018
Operating Temperature	°C	-50 ... 120	-50 ... 120
Power Supply	mA	4	4
	VDC	20 ... 32	20 ... 32
Housing/Base	type	St. Stl.	St. Stl.
Sealing	type	Hermetic	Hermetic
Mass	gram	19	19

Measuring direction Connection
10-32 neg.

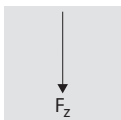

Characteristics
Low impedance, voltage mode, rugged quartz sensor, wide measuring ranges, uses standard low cost cables, CE compliant

Applications
Force applications where high sensitivity, high rigidity and fast responses are required

Accessories
Cable: Type 1761B...
Coupler: Type 5100 series
Impact pad: Type 900A1

Datasheet 9712_000-417

Impulse

Voltage Output Force Sensor

Impulse Force Hammer Type 9722A...



Specifications		Type 9722A500	Type 9722A2000
Force Range	N	0 ... 500	0 ... 2 000
Frequency Range, -10 dB	Hz	8 200	9 300
Resonant Frequency	kHz	27	27
Sensitivity (nom.)	mV/N	10	2
Rigidity	kN/ μ m	0,8	0,8
Time Constant	s	500	500
Operating Temperature	$^{\circ}$ C	-20 ... 70	-20 ... 70
Power Supply	mA	2 ... 20	2 ... 20
	VDC	20 ... 30	20 ... 30
Length of handle	mm	188	188
Hammer Head Dimensions:			
Diameter	mm	17,5	17,5
Length	mm	61	61
Mass	gram	100	100

Measuring direction Connection
BNC neg.

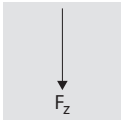

Characteristics
Low impedance voltage mode, quartz force sensing element guarantees long-term stability, sensor cable integrated to hammer handle, CE compliant

Applications
Analyze the dynamic behavior of mechanical structures

Accessories
Cable: Type 1601B...
Coupler: Type 5100 series

Datasheet 9722A_000-272

Impulse Force Hammer Type 9724A...



Specifications		Type 9724A2000	Type 9724A5000
Force Range	N	0 ... 2 000	0 ... 5 000
Frequency Range, -10 dB	Hz	6 600	6 900
Resonant Frequency	kHz	27	27
Sensitivity (nom.)	mV/N	2	1
Rigidity	kN/ μ m	0,8	0,8
Time Constant	s	500	500
Operating Temperature	$^{\circ}$ C	-20 ... 70	-20 ... 70
Power Supply	mA	2 ... 20	2 ... 20
	VDC	20 ... 30	20 ... 30
Length of handle	mm	231	231
Hammer Head Dimensions:			
Diameter	mm	23	23
Length	mm	89	89
Mass	gram	250	250

Measuring direction Connection
BNC neg.

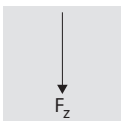

Characteristics
Low impedance voltage mode, quartz force sensing element guarantees long-term stability, sensor cable integrated to handle of hammer, CE compliant

Applications
Analyze the dynamic behavior of mechanical structures

Accessories
Cable: Type 1601B...
Coupler: Type 5100 series

Datasheet 9724A_000-273

Impulse

Voltage Output Force Sensor

Impulse Force Hammer Type 9726A...



Specifications		Type 9726A5000	Type 9726A20000
Force Range	N	0 ... 5 000	0 ... 20 000
Frequency Range, -10 dB	Hz	5 000	5 400
Resonant Frequency	kHz	27	27
Sensitivity (nom.)	mV/N	1	0,2
Rigidity	kN/ μ m	0,8	0,8
Time Constant	s	500	500
Operating Temperature	$^{\circ}$ C	-20 ... 70	-20 ... 70
Power Supply	mA	2 ... 20	2 ... 20
	VDC	20 ... 30	20 ... 30
Length of handle	mm	236	236
Hammer Head Dimensions:			
Diameter	mm	32	32
Length	mm	94	94
Mass	gram	500	500

Measuring direction Connection
BNC neg.

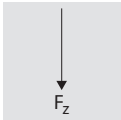

Characteristics
Low impedance voltage mode, quartz force sensing element guarantees long-term stability, sensor cable integrated to hammer handle, CE compliant

Applications
Analyze the dynamic behavior of mechanical structures

Accessories
Cable: Type 1601B...
Coupler: Type 5100 series

Datasheet 9726A_000-274

Impulse Force Hammer Type 9728A...



Specifications		Type 9728A20000
Force Range	N	0 ... 20 000
Frequency Range, -10 dB	Hz	1000
Resonant Frequency	kHz	20
Sensitivity (nom.)	mV/N	0,2
Rigidity	kN/ μ m	2,7
Time Constant	s	500
Operating Temperature	$^{\circ}$ C	-20 ... 70
Power Supply	mA	2 ... 20
	VDC	20 ... 30
Length of handle	mm	343
Hammer Head Dimensions:		
Diameter	mm	51
Length	mm	154
Mass	gram	1500

Measuring direction Connection
BNC neg.

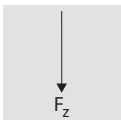

Characteristics
Low impedance voltage mode, quartz force sensing element guarantees long-term stability, sensor cable integrated to handle of hammer, CE compliant

Applications
Analyze the dynamic behavior of mechanical structures

Accessories
Cable: Type 1601B...
Coupler: Type 5100 series

Datasheet 9728A_000-275

Electronics & Software

Powering, conditioning and computer interface solutions are available from a suite of electronic equipment tailored to provide measurement flexibility with utmost quality and integrity. Couplers from inexpensive single channel to large, modular, multi-channel platforms can be selected. Charge amplifiers with dual mode (low and high impedance) capability offer adaptability to a variety of sensor configurations. Gain, filtering, and conditioning aspects of the measurement chain are contained in this section of the catalogue.



Electronics & Software

Signal Conditioner

Charge Meter Type 5015A



Specifications		Type 5015A
Measuring Range	pC	±2 ... 2 200 000
Frequency Response (wide band)	Hz	~0 ... 200 k
Output Voltage	V	±10 ... ±2
Output Current	mA	2
Accuracy (range dependent)	%	<±3 ... <±0,5
Power	VAC	115/230
Temperature Range	°C	0 ... 50
Dimensions with frame	mm	105,3 W x 142 H x 253,15 D
Mass	kg	2,3

Connection

Input & output:
BNC neg.
Remote control:
6 pin; DIN 45322
RS-232C:
9-pin D-Sub

Characteristics

Single-Channel charge amplifier
Piezotron input (option), menu-
driven operation, direct signal
evaluation, CE compliant

Applications

Measure dynamic pressure,
force strain and acceleration
from piezoelectric sensors

*Contact Kistler for different
versions of this Charge Meter

Datasheet 5015A_000-297

In-Line Charge Converter Module Type 5050A...



Specifications		Type 5050A0.1	Type 5050A1	Type 5050A10
Sensor Signal Voltage	V _{pp}	10	10	10
Gain	mV/pC	0,1	1	10
Noise (Broad Band 1 ... 10kHz)	μV _{rms}	5	10	70
Input Resistance min.	kΩ	100	100	100
Input Capacitance	nF	30	30	30
Frequency Response -5%	Hz	1 ... 20 000	1 ... 20 000	1 ... 20 000
Constant Current	mA	2 ... 18	2 ... 18	2 ... 18
Compliance Voltage	VDC	20 ... 30	20 ... 30	20 ... 30
Operating Temperature Range	°C	-40 ... 80	-40 ... 80	-40 ... 80
Signal Polarity		inverted	inverted	inverted
Sealing	type	Welded/Epoxy	Welded/Epoxy	Welded/Epoxy
Housing	material	Stainless Steel	Stainless Steel	Stainless Steel
Input Connector	type	10-32 neg.	10-32 neg.	10-32 neg.
Output Connector	type	BNC neg.	BNC neg.	BNC neg.
Mass	gram	28	28	28

Connection:
BNC neg.

Characteristics:

Two wire, single ended device,
rugged, stainless steel case,
wide frequency response, three
gain versions, CE conforming

Applications:

High temp. measurements
where a low impedance device
cannot withstand the environ-
ment

Accessories:

Cable: Type 1635C....
Coupler: Type 5100 series

Datasheet 5050A_000-452

Electronics & Software

Signal Conditioner

Piezotron Low Impedance Coupler Type 5108A

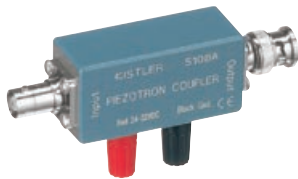

Specifications		Type 5108A
Sensor Supply Current	mA	4
Sensor Signal Voltage	V _{pp}	20
Frequency Response, (5 V _{pp} & 2 m cable)	Hz	0,02 ... 87 k
Output Voltage	V _{pp}	20
Gain		1
Power	VDC	22 ... 30
Temperature Range	°C	0 ... 50
Power	type	Banana jacks
Dimensions	mm	57,2 L x 22,2 H x 22,2 W
Mass	gram	65

Connection

Input: BNC neg.
Output: BNC pos.
Power: banana jacks, polarity (+ red, - black)

Characteristics

Simple to operate, AC coupled, reverse polarity protection, CE compliant. Use with low impedance Piezotron sensors with built-in electronics

Accessories

Cable: Type 1761B...

Datasheet 5108A_000-328

Multimeter Coupler Type 5110



Specifications		Type 5110
Input: Excitation current (± 10%)	mA	2
Input: No load voltage	VDC	≤ 20
Output: Voltage swing	V _{pp}	≤ 18
Output: Voltage gain		1
Output to BNC connector:		
Frequency Response, ± 5% 5 V _{pp}	Hz	0,07 ... 60 000
Time Constant (±10%)	s	10
Output to Multimeter:		
Frequency Response, ± 5% 5 V _{pp}	Hz	0 ... 60 000
Internal battery	Type	9V alkaline (IEC 6LR61)
Case Dimensions	mm	96,5 L x 25,4 H x 61,0 W
Weight (battery included):	gram	150
Connectors: Sensor, Output	Type	BNC neg.
Connectors: Multimeter	Type	Banana
Temperature Range Operating	°C	-10 ... 54

Connection:

Input: BNC neg.
Output: BNC neg.
Multimeter:
Banana jacks

Characteristics:

Turn a digital multimeter into a hand-held relative vibration measurement system or verify sensor and cable integrity with this portable, low cost, battery-operated coupler

Accessories:

Kit: Type 5110S1 kit includes 5110, carrying case, mounting wax and 9 V battery

Datasheet 5110_000-329

Electronics & Software

Signal Conditioner

Power Supply/Coupler Type 5114



Specifications		Type 5114
Sensor Excitation Current	mA	2
Sensor Excitation Voltage	VDC	20
Frequency Response	Hz	0,07 ... 60 k
Output Voltage	Vpp	20
Gain		1
Power	VDC	9
Temperature Range	°C	-10 ... 54
Mass	gram	250

Connection

Input & output:
BNC neg.
External power:
2,1 mm jack

Characteristics

Provides constant current excitation, monitors condition and sensors and cables, 3,5 digit LCD display AC-DC or battery powered, CE compliant

Application

Power and monitor Piezotron sensors

Accessories

AC-DC power adaptor:
Type 5752 (120 V)
Type 5757 (230 V)

Specify Version

5114: supplied with 9 V alkaline battery
5114S1: supplied with 9 V alkaline battery, 115 VAC power adaptor and carrying case
5114S1(E): same as S1 only with 230 VAC power adaptor, 9 V alkaline battery

Datasheet 5114_000-330

Power Supply/Coupler Type 5118B...



Specifications		Type 5118B2
Sensor Supply Current	mA	2
Sensor Signal Voltage	Vpp	10
Frequency Response, ±5	Hz	0,02 ... 40 k
Output Voltage	Vpp	20
Gain		1, 10, 100
Power Supply	Battery	4 x 1,5 V AA, alkaline
Temperature Range	°C	-20 ... 50
Dimensions	mm	91 W x 46 H x 191 D
Mass	kg	0,5

Connection

Input & output:
BNC neg.

Characteristics

Selectable gain and low pass, plug-in filters, high pass filtering, panel selectable, exclusive "Rapid Zero" feature AC-DC or battery powered, CE compliant

Applications

Powering low impedance sensors where test conditions require flexible signal conditioning

Optional Accessories

AC-DC power adaptor (115 VAC):
Type 5752
AC-DC power adaptor (230 VAC):
Type 5757
Panel mounting kit: Type 5702
Low/high pass filters

Datasheet 5118B_000-331

Electronics & Software

Signal Conditioner

AE Coupler Type 5125B..., Piezotron Coupler Type 5127B...



Specifications		Type 5125B	Type 5127B
Sensor Excitation Current	mA	4	4
Sensor Signal Voltage	V _{pp}	16	20
Frequency Response, ±5	Hz	15 k ... 1 M	0,1 ... 30 k
Output Voltage	V _{pp}	10	20
Gain		10, 100	1, 10
Power	mA	< 70	50
	VDC	15 ... 36	22 ... 30
Temperature Range	°C	0 ... 60	0 ... 60
Housing	type	aluminium	aluminium
Dimensions	mm	114 W x 147 H x 36 D	114 W x 147 H x 36 D
Mass	kg	0,270	0,270

Connection

Input: BNC neg. or cable strain relief

Output: 8-pole round connector DIN 45326

Characteristics

Built-in RMS converter and limit monitor, plug-in filter elements, rugged case, vibration-proof construction, CE compliant

Applications

Vibration and acoustic emission (AE) sensors, 5125B AE coupler, 5127B Piezotron coupler

Accessories

8-pole round connector: Type 1500A57
Low/high pass filters

Specify Version

request data sheet below for all ordering options

Datasheet 5127_000-323

Four Channel Piezotron Coupler Type 5134A1



Specifications		Type 5134A1
Sensor Excitation Current	mA	4
Sensor Excitation Voltage	VDC	20
Frequency Response	Hz	0,04 ... 30 k
Output Voltage	V _{pp}	20
Gain (7 set points)		1, 2, 5, 10, 20, 50, 100
Power	VAC	115/230
Temperature Range	°C	0 ... 50
Dimensions	mm	94 W x 150 H x 196 D
Mass	kg	1,8

Connection

Input & output: BNC neg.

Characteristics

RS-232C interface for remote control and monitoring, sensors circuit open/short alarm, non volatile memory for set parameters, seven selectable gains, four selectable low pass filters, CE compliant

Applications

General vibration lab use with single axis or triaxial accelerometers

Specify Version

Without case: Type 5134A0

Datasheet 5134A_000-332

Electronics & Software

Signal Conditioner

16-Channel Power Supply/Coupler Type 5148



Specifications		Type 5148
Sensor Excitation Current	mA	4
Sensor Excitation Voltage	VDC	24
Frequency Response, ± 5	Hz	0,05 ... 50 k
Output Voltage	Vpp	20
Gain		1
Power	VDC	115/230
Temperature Range	°C	0 ... 50
Dimensions	mm	483 W x 45 H x 222 D
Mass	kg	2,5

Connection

Input rear:
16 BNC neg.

Output rear:
16 BNC neg.

Output front:
16 BNC neg.

Characteristics

Provides constant current excitation for Piezotron and voltage mode piezoelectric sensors, LED's indicate circuit integrity, convenient front/rear BNC connectors, standard rack mountable, CE compliant

Applications

Multi-channel low impedance sensor power at economical price per channel

Datasheet 5148_000-333

Impedance Converter and Capacitor Type 557, 558



Specifications		Type 557, 558
Sensor Signal Voltage	Vpp	10
Output Signal Voltage	Vpp	10
Gain		0,97
Excitation Voltage	VDC	20 ... 30
	mA	4
Range Capacitance (nom.)	pF	3
Input Resistance	Ω	5×10^{10}
Temperature Range	°C	-55 ... 120
Sealing	type	Welded/Epoxy
Mounting	on sensor	type 557
	in-line	type 558

Connection

557
10-32 pos.
10-32 neg.

558
10-32 pos.

Characteristics

Compatible with high impedance, miniature construction In-line or direct attachment to sensor, optional range capacitors to tailor output signal, two wire constant current, source operation

Application

Conversions of charge signals from piezoelectric sensors into proportional voltage signals. High temperature installations requiring charge output sensors

Accessoires

571A... Range capacitors available

Datasheet 557_000-388

Electronics & Software

Signal Conditioner

K-Beam Power Supply Type 5210



Specifications		Type 5210
Sensor Excitation Current	mA	25
Sensor Excitation Voltage	V	9
Frequency Response	Hz	0 ... 750
Output Voltage	V	±8
Gain		1, 2, 10, 20
Power	Battery	9 V
Temperature Range	°C	-10 ... 54
External DC input	type	2,1 mm jack
Dimensions	mm	146 L x 91,4 W x 32,8 H
Mass	gram	260

Connection

Sensor: 4-pin, Microtech pos.
Output signal: BNC neg.
External DC input: 2,1 mm jack (tip+)

Characteristics

Adjustable offset control for higher resolution measurements, battery or external power, gain and filtering options, low battery indicator, complete kit available, CE compliant

Applications

Power any single K-Beam accelerometer from a casual check to an in-depth study

Accessories

AC-DC power adaptor (115 VAC): Type 5752
AC-DC power adaptor (230 VAC): Type 5757

Specify Version

5210: supplied with 9 V battery
5210S1: supplied with 9 V battery, 115 V power adaptor 5752 and carrying case
5210S1(E): same as S1 only with 230 V power adaptor 5757, 9 V battery and carrying case

Datasheet 5210_000-334

Insulation Tester Type 5493



Specifications		Type 5493
Measuring Range	Ω	10 ¹¹ to 4 x 10 ¹³
Measuring Voltage	V	5
Admissible Voltage, max.	V	700
Measurement display		logarithmic
Battery Power	VDC	9
Dimensions	mm	150 L x 79 W x 36 H
Mass	gram	290

Connection

BNC neg.

Characteristics

Small, robust, for measuring high insulation resistance on the spot; low measuring voltage of 5 V, logarithmic indication avoids the need for range switching, automatic switchoff, CE compliant

Applications

Measure insulation resistance of cables and equipment

Datasheet 5493_000-354

Vibration Switch

K-Guard Industrial Vibration Switch Type 8810



Specifications		Type 8810
Frequency Range -3 dB	Hz	10 ... 1000
Velocity Range	mm/sec	100
Setpoint Range	mm/sec	2 ... 50
Setpoint Accuracy	%	±10
Sensitivity	mV/mm/sec	50
Operating Temperature	°C	0 ... 60
Power Supply	mA	50
	VDC	18 ... 30
Humidity	%	10 ... 90
Integral Cable Length	m	3
Mass	gram	400

Connection
pigtaills

Characteristics
A vibration monitor with, velocity trip, monitor outputs, adjustable time delay, small size and lightweight, CE compliant

Applications
Vibration monitoring on cooling towers and machinery such as fans, motors, conveyers, motor/generator sets, centrifugal pumps, and other types of industrial machinery

Datasheet 8810_000-268

Accessories

Common accessories extend the flexibility of the accelerometer families often adapting to less than optimal conditions. For instance, the variety of adhesive mounting pads provide ground isolation while permitting a reasonable attachment in situations where tapping a threaded hole is unacceptable. A series of magnet mounts provides an alternate solution if the structure is a ferrous material. Also included in this section are a variety of conversion studs to accommodate a previous mounting site with a different accelerometer with different threads. Mounting cubes provide a means of obtaining accurate orthogonal measurements at a reasonable cost.

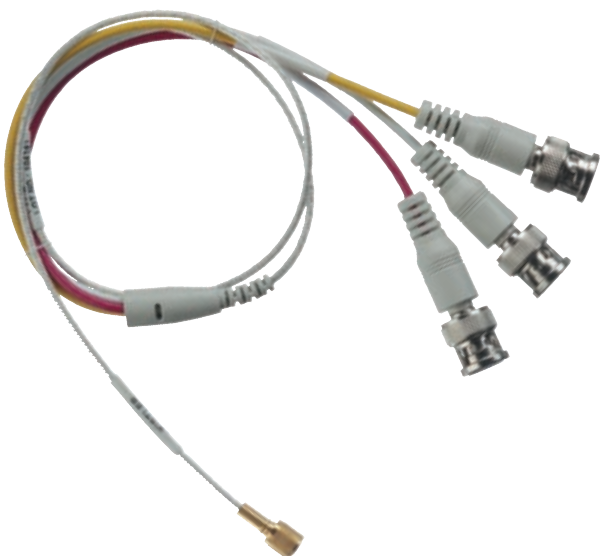

Accessories

Mounting

Adhesive Mounting Type 8434, 8436, 8438

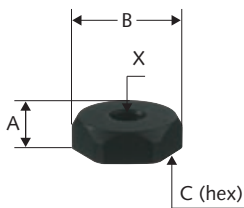

Specifications		Type 8434	Type 8436	Type 8438
A	mm	4,8	4,8	7,9
B	mm	12,5	15,7	21,1
C	mm	11,2	14,2	19
D	mm	–	–	–
Thread X		5-40	10-32	1/4-28
Mass	gram	1,25	1,96	5,78
Material		Anodized Aluminium		
Recommended Sensors		8730A, 8791A	8202A, 8284A, 8702B, 8704B, 8774A, 8784A, 8786A	8203A, 8710A, 8712A, 8752A, 8795A* (* With 8410 mounting stud)

Adhesive Mounting Type 8439, 8440

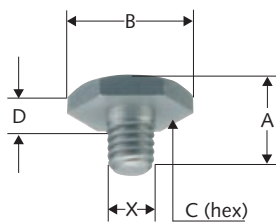

Specifications		Type 8439	Type 8440
A	mm	5,1	5,1
B	mm	7,1	7,1
C	mm	6,3	6,3
D	mm	1,5	1,5
Thread X		M3	4-40
Mass	gram	0,18	0,18
Material		Anodized Aluminium	Anodized Aluminium
Recommended Sensors		8614A	8614A

Magnetic Mounting Type 8450, 8452, 8456

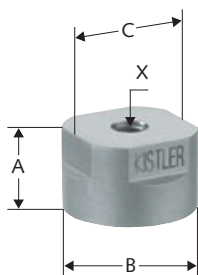

Specifications		Type 8450A	Type 8452A	Type 8456
A	mm	7,6	11,2	11,2
B	mm	12,7	17,8	24,9
C	mm	11,1	15,9	–
Thread X		5-40	10-32	1/4-28
Holding Force	N	26,7	53,4	133
Mass	gram	6	19	57
Material		17-4 PH	17-4 PH	17-4 PH
Recommended Sensors		8636C, 8730A	8202A, 8702B, 8704B, 8774A, 8784A, 8786A, 8795A	8203A, 8710A, 8712A, 8752A

Datasheet 8434_000-281

Accessories

Mounting

Magnetic Mounting Type 8458

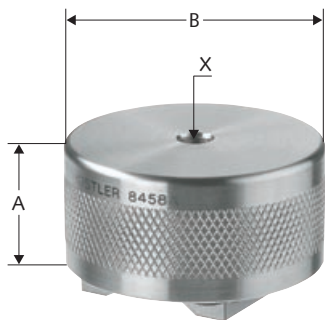

Specifications		Type 8458(1)
A	mm	31,7
B	mm	47,0
C	mm	–
Thread X		1/4-28
Holding Force	N	178
Mass	gram	102
Material		17-4 PH
Recommended Sensors		8203A, 8710A, 8712A, 8752A

Mounting Stud Type 8402, 8404, 8410

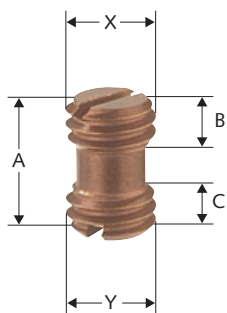

Specifications		Type 8402	Type 8404	Type 8410
A	mm	7,1	7,1	6,4
B	mm	2,5	2,5	2,0
C	mm	2,5	2,5	3,3
Thread X		10-32	10-32	10-32
Thread Y		10-32	10-32	1/4-28
Material		BeCu	17-4 PH	BeCu
Recommended Sensors		8202A, 8290A25, 8638B, 8702B, 8704B, 8770A, 8786A, 8795A	8044	–

Mounting Stud Type 8411, 8416, 8418

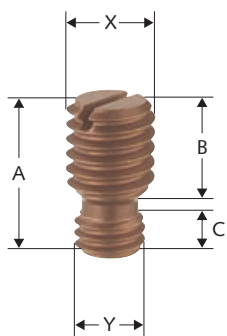

Specifications		Type 8411	Type 8416	Type 8418
A	mm	10,9	6,6	7,1
B	mm	3,3	2,3	2,3
C	mm	6,4	3,3	3,8
Thread X		10-32	5-40	5-40
Thread Y		M6	10-32	M6
Material		BeCu	316 St. Stl.	316 St. Stl.
Recommended Sensors		8702B, 8704B, 8770A, 8774A, 8784A, 8786A, 8795A	8636C	8636C

Datasheet 8434_000-281

Accessories

Mounting

Mounting Stud Type 8421, 8412, 8420

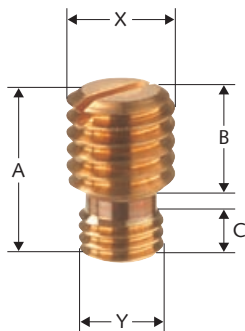

Specifications		Type 8421	Type 8412	Type 8420
A	mm	13,2	9,4	9,4
B	mm	6,4	–	–
C	mm	4,6	–	–
Thread X		M8	1/4-28	5-40
Thread Y		1/4-28	–	–
Material		BeCu	18-8 St. Stl.	18-8 St. Stl.
Recommended Sensors		8203A, 8710A, 8712A, 8752A	8203A, 8710A, 8712A, 8752A	8636

Mounting Stud Type 8414

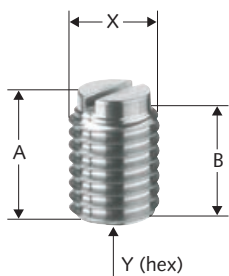

Specifications		Type 8414
A	mm	8,9
B	mm	8,1
Thread C		–
Thread X		1/4-28
Y		10-32
Material		17-4 PH St. Stl.
Recommended Sensors		8710A, 8712A, 8752A (adapts a 10-32 Mounting Stud into a 11/4-28 Mounting Hole)

Magnetic Mounting Type 8516, 8518, 8530

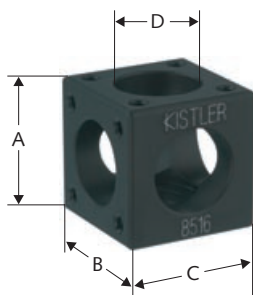

Specifications		Type 8516	Type 8518	Type 8530
A	mm	25,4	40,7	33,0
B	mm	25,4	40,7	33,0
C	mm	25,4	40,7	33,0
D	mm	15,1	15,1	22,1
Mass	gram	20	26,3	38
Material		Al.	Al.	Al.
Recommended Sensors		8305	8310, 8312	8330

Mounting Clip Type 8474, 8476

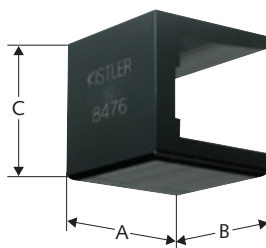

Specifications		Type 8474	Type 8476
A	mm	19,5	25,4
B	mm	17,8	25,4
C	mm	18,5	25,4
Mass	gram	5	10
Material		Derlin	Derlin
Recommended Sensors		8772	8690

Datasheet 8434_000-281

Accessories

Cable



Specifications		Type
		1511
Connection		BNC pos. BNC pos.
Length	m	1/sp*
Diameter	mm	6,4
Used for		Used for charge amplifier and coupler output signals



Specifications		Type
		1576
Connection		4-pin pos. 3x BNC pos.
Length	m	0,2
Diameter	mm	1,78
Used for		Distribution cable for 8694M1



Specifications		Type
		1592A
Connection		4-pin neg. 4-pin neg.
Length	m	2/4/sp*
Diameter	mm	2,49
Used for		General purpose extension cable



Specifications		Type
		1601B
Connection		BNC pos. BNC pos.
Length	m	sp*
Diameter	mm	6,35
Used for		High impedance charge mode cables, commonly used as extension cables



Specifications		Type
		1603B
Connection		BNC neg. BNC pos.
Length	m	sp*
Diameter	mm	3,00
Used for		High impedance charge mode cables, commonly used as extension cables



Specifications		Type
		1631C
Connection		10-32 pos. BNC pos.
Length	m	1/2/3/5/8/sp*
Diameter	mm	2,01
Used for		High impedance charge mode cables

Datasheet 1511_000-471

sp* = special length, according to customer specifications

Accessories

Cable



Specifications		Type
		1635C
Connection		10-32 pos. 10-32 pos.
Length	m	1/2/3/5/8/sp*
Diameter	mm	2,01
Used for		High impedance charge mode cables



Specifications		Type
		1641
Connection		10-32 pos. BNC pos.
Length	m	sp*
Diameter	mm	2,01
Used for		High impedance charge mode cables



Specifications		Type
		1756B
Connection		4-pin neg. 3x BNC pos.
Length	m	0,5/3/10/sp*
Diameter	mm	1,78
Used for		Triaxial accelerometers: Types 8690 8692, 8791, 8793, 8794, 8795



Specifications		Type
		1761B
Connection		10-32 pos. BNC pos.
Length	m	1/2/3/5/sp*
Diameter	mm	2,01
Used for		Teflon insulated, voltage mode cables



Specifications		Type
		1762B
Connection		10-32 pos. 10-32 pos.
Length	m	1/2/3/5/sp*
Diameter	mm	2,01
Used for		Teflon insulated, voltage mode cables



Specifications		Type
		1770A
Connection		MS3106 (MIL-C-5015) BNC pos.
Length	m	3/sp*
Diameter	mm	6,35
Used for		Aluminium, with backshell and strain relief, for applications below 250 °C

Datasheet 1511_000-471

sp* = special length, according to customer specifications

Accessories

Cable



Specifications		Type
		1772A
Connection		MS3106 (MIL-C-5015) BNC pos.
Length	m	3/sp*
Diameter	mm	6,35
Used for		Aluminium, with backshell and strain relief, for applications below 350 °C



Specifications		Type
		1776A
Connection		MS3106 (MIL-C-5015) BNC pos.
Length	m	3/sp*
Diameter	mm	6,35
Used for		Silicon, quick disconnect, splash proof, for applications below 250 °C



Specifications		Type
		1778A
Connection		MS3106 (MIL-C-5015) BNC pos.
Length	m	3/sp*
Diameter	mm	6,35
Used for		Silicon, quick disconnect, splash proof, for applications below 350 °C



Specifications		Type
		1784AK02
Connection		Mini 4-pin neg
Connection		4-pin pos.
Length	m	0,5
Diameter	mm	1,5
Used for		Sensors with the Kistler Mini 4-pin connector (8763 & 8765)



Specifications		Type
		1784AK03
Connection		Mini 4-pin neg
Connection		(3) BNC pos.
Length	m	1/5/10
Diameter	mm	1,5
Used for		Sensors with the Kistler Mini 4-pin connector (8763 & 8765) in triaxial applications

Datasheet 1511_000-471

sp* = special length, according to customer specifications

Accessories

Cable



Specifications		Type
		1786C
Connection		4-pin neg. 2x Banana Jacks for power, BNC pos. signal out
Length	m	2/5/10/20
Diameter	mm	2,67
Used for		Breakout power supply cable: Type 8304, 8310, 8324, 8838, 8840



Specifications		Type
		1788A
Connection		4-pin neg. 3x Banana Jacks for power, BNC pos. signal out
Length	m	sp*
Diameter	mm	2,67
Used for		Breakout power supply cable: Type 8330



Specifications		Type
		1790A2
Connection		9-pin Micro pos. 9-pin D-sub pos.
Length	m	2
Diameter	mm	4,45
Used for		Mating cable: Type 8393



Specifications		Type
		1794A
Connection		9-pin D-sub pos. 2x Banana Jacks for power, 3x BNC pos. signal out
Length	m	sp*
Diameter	mm	2,67
Used for		Breakout power supply cable: Type 8393

Datasheet 1511_000-471

sp* = special length, according to customer specifications

Accessories

Electronic (Interfaces)

TEDS Editor Type 5000M04



The module is used in conjunction with a personal computer to read and write information stored in TEDS capable sensors. The supplied software allows for data to be written and read using the following template formats:

- P1451.4 v0.9 template 0 (UTID 1)
- P1451.4 v0.9 template 24 (UTID 116225)
- LMS template 117 for free format point id
- LMS template 118 for geometry format point id (automotive and aerospace resolutions)
- P1451.4 v1.0 template 25

Calibration

Kistler takes pride in its control and concern for the integrity and accuracy of our calibration system. Our system is compliant with ANSI/NCSL Z540-1-1994, MIL-STD-45662A, ISO 9001:2000 and now is fully accredited to ISO/IEC 17025. Considerable resources in personnel and equipment have been devoted to the maintenance and management of this system and all primary and working standards used in calibration of our products.

Kistler believes that, not only are you buying a technically superior product, guaranteed to meet or exceed your expectations, but you are also buying a calibration certificate attesting to the performance, accuracy and traceability of your device.

All Kistler products are calibrated using NIST traceable calibration standards, whose reliability and repeatability have been demonstrated through periodic verification and historical data. In fact, Kistler products are used as primary standards in many well known calibration laboratories throughout the world.



Calibration

Charge Amplifier

Calibration Systems Types 8802, 8804



Specifications		Type 8802	Type 8804
Acceleration Range	g	±250	±250
Acceleration Limit	g	±1000	±1000
Threshold	g_{rms}	0,02	0,01
Ref. Voltage Sensivity at 100 Hz, 10 g and 23,9 °C	mV/g	10 ±0,01	10 ±0,01
Frequency Response	Hz	10 ... 10 000	10 ... 10 000
Transverse Sensivity at 100 Hz	pC/s	≤2	≤2
Time Constant	s	1	1
Non-Linearity	%	±0,5	±0,5
Operating Temperature	°C	-21 ... 57	-21 ... 57
Temp. Coeff. of Sensivity	%/°C	-0,04	-0,04
Output Voltage FSO	V	±2,5	±2,5
Ground Isolation	Ω	-	>10 ⁷
Output Impedance	Ω	<15	<15
Power Supply	VAC	115/230	115/230
Mass	Gramm	20	80

Connection
10-32 neg.

Characteristics
This system features unique stability, linearity and repeatability

Applications
System for calibration of sensors. Lab standard or back-to-back calibration transfer

System Components
8802 = 8002/5022
8804 = 8076/5022

Datasheet 8802_000-520
8804_000-521

Reference Shaker Type 8921



Specifications		Type 8921Y26
Frequency	Hz (rads)	159,2 (1000)
Acceleration rms, ±3%	g	1
Velocity rms, ±3%	mm/sec	10
Displacement rms, ±3%	µm	10
Max. Load	gram	300
Operating Temp.	°C	10 ... 40
Power Supply	mA	300
	VDC	12
Battery	type	built-in rechargeable
Mass	kg	2
Dimensions	mm	76,2 H x 107 W x 178 D

Characteristics
Test measurement system integrity, convenient self-contained and portable, rechargeable battery, tests sensors up to 300 g of weight, CE compliant

Applications
The 8921 reference shaker can be used to confirm the sensitivity of acceleration, velocity, and displacement sensors

Accessories
10-32 to M5 stud: Type 8451
1/4 -28 to M5 stud: Type 8453

Specify Version
8921Y26: supplied with 115 VAC battery charger
8921: supplied with 230 VAC battery charger

Datasheet 8921_000-362

Calibration

Charge Amplifier

Quartz Compression Laboratory Primary Standard Accelerometers Type 8002K...

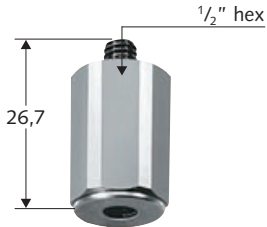

Specifications		Type 8002K
Range	g	±1000
Sensitivity	pC/g	-1,0
Frequency Response, -1 ... 5%	Hz	≈0 ... 6000
Threshold nom.	g_{rms}	0,02
Transverse Sensitivity max.	%	2
Non-Linearity	%FSO	±0,5
Temp. Coeff. of Sensitivity	%/°C	-0,03
Operating Temperature	°C	-70 ... 120
Housing/Base	type	St. Stl.
Sealing	type	Epoxy
Mass	gram	20
Sensing Element	type	Quartz/compression

Measuring direction Connection
10-32 neg.

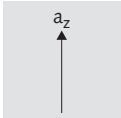

Characteristics
High impedance, charge mode, quartz stability and repeatability, wide operating temperature range.

Applications
Used with 5022 to form a complete calibration primary standard. Long duration shock pulses or high frequency vibrations even in cryogenic or high temperature environments.

Accessories
Mounting Stud: Type 8402
Cable: 1631C...
Charge Amplifier: 5022

Datasheet 8002_000-205

Vibration Standard Quartz Accelerometer Type 8076K

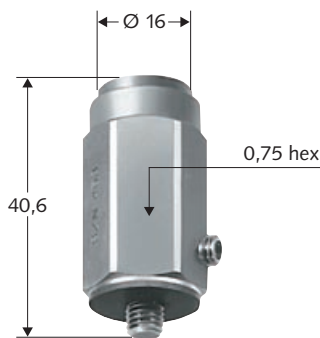

Specifications		Type 8076K
Range	g	±1000
Sensitivity	pC/g	1
Frequency Response, ±4%	Hz	0,5 ... 5000
Threshold nom.	g_{rms}	0,01
Transverse Sensitivity max.	%	2
Non-Linearity	%FSO	±0.5
Temp. Coeff. of Sensitivity	%/°C	0,02
Operating Temperature	°C	-20 ... 65
Housing/Base	type	St. Stl.
Sealing	type	Epoxy
Mass	gram	80
Sensing Element	type	Quartz/compression

Measuring direction Connection
10-32 neg.

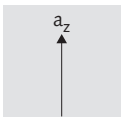

Characteristics
High impedance charge mode, quartz accuracy and stability, rugged design, low base strain sensitivity, ground isolated. Low mass loading

Applications
Used with 5022 to form a complete back-to-back calibration transfer standard. High precision laboratory accelerometer

Accessories
Mounting Stud: Type 8410
Cable: 1631C...
Charge Amplifier: 5022

Datasheet 8076K_000-210

Piezoelectric Theory

Piezoelectric effect

The piezoelectric effect was discovered by Pierre and Jacques Curie in 1880. It remained a mere curiosity until the 1940's. The property of certain crystals to exhibit electrical charges under mechanical loading was of no practical use until very high input impedance amplifiers enabled engineers to amplify their signals. In the 1950's electrometer tubes of sufficient quality became available and the piezoelectric effect was commercialized.

Walter P. Kistler patented the charge amplifier principle in 1950 and gained practical significance in the 1960's. The introduction of highly insulating materials such as Teflon and Kapton greatly improved performance and propelled the use of piezoelectric sensors into virtually all areas of modern technology and industry.

Piezoelectric measuring systems are active electrical systems. That is, the crystals produce an electrical output only when they experience a change in load. For this reason, they cannot perform true static measurements. However, it is a misconception the piezoelectric instruments are suitable for only dynamic measurements. Quartz transducers, paired with adequate signal conditioners, offer excellent quasistatic measuring capability. There are countless examples of applications where quartz based sensors accurately and reliably measure quasistatic phenomena for minutes and even hours.

Applications of piezoelectric instruments

Piezoelectric measuring devices are widely used today in the laboratory, on the production floor and as original equipment. They are used in almost every conceivable application requiring accurate measurement and recording of dynamic changes in mechanical variables such as pressure, force and acceleration. The list of applications continues to grow and now includes:

- Aerospace: Modal testing, wind tunnel and shock tube instrumentation, landing gear hydraulics, rocketry, structures, ejection systems and cutting force research
- Ballistics: Combustion, explosion, detonation and sound pressure distribution
- Biomechanics: Multi-component force measurement for orthopedic gait and posturography, sports, ergonomics, neurology, cardiology and rehabilitation
- Engine Testing: Combustion, gas exchange and injection, indicator diagrams and dynamic stressing
- Engineering: Materials evaluation, control systems, reactors, building structures, ship structures, auto chassis structural testing, shock and vibration isolation and dynamic response testing
- Industrial/Factory: Machine systems, metal cutting, press and crimp force, automation of force-based assembly operations and machine health monitoring
- OEMs: Transportation systems, plastic moulding, rockets, machine tools, compressors, engines, flexible structures, oil/gas drilling and shock/vibration testers.

Piezoelectric sensors (Quartz based)

The vast majority of Kistler sensors utilize quartz as the sensing element. As discussed in other sections of this catalogue, Kistler also manufactures sensors which utilize piezo-ceramic elements and micro machined silicon structures. However, the discussion in this section will be limited to quartz applications. Quartz piezoelectric sensors consist essentially of thin slabs or plates cut in a precise orientation to the crystal axes depending on the application. Most Kistler sensors incorporate a quartz element, which is sensitive to either compressive or shear loads. The shear cut is used for patented multi-component force and acceleration measuring sensors. Other specialized cuts include the transverse cut for some pressure sensors and the patented polystable cut for high temperature pressure sensors. See figures 1 and 2.

Although the discussion which follows focuses on accelerometer applications, the response function for force and pressure sensors has essentially the same form. In fact, many force applications are closely related to acceleration. On the other hand, pressure sensors are designed to minimize or eliminate (by direct compensation of the charge output) the vibration effect. Call Kistler directly for more information on this subject or refer to page 100 which lists available technical articles.

The finely lapped quartz elements are assembled either singly or in stacks and usually preloaded with a spring sleeve. The quartz package generates a charge signal (measured in picoCoulombs) which is directly proportional to the sustained force. Each sensor type uses a quartz configuration which is optimized and ultimately calibrated for its particular application (force, pressure, acceleration or strain). Refer to the appropriate section for important design aspects depending on application.

Quartz sensors exhibit remarkable properties, which justify their large scale use in research, development, production and testing. They are extremely stable, rugged and compact. Of the large number of piezoelectric materials available today, quartz is employed preferentially in sensor designs because of the following excellent properties:

- High material stress limit, approximately 150 N/mm²
- Temperature resistance up to 500 °C
- Very high rigidity, high linearity and negligible hysteresis
- Almost constant sensitivity over a wide temperature range
- Ultra high insulation resistance (10¹⁴ ohms) allowing low frequency measurements (<1 Hz)

High and low impedance

Kistler supplies two types of piezoelectric sensors: high and low impedance. High impedance units have a charge output which requires a charge amplifier or external impedance converter for charge-to-voltage conversion. Low impedance types use the same piezoelectric sensing element as high impedance units and also incorporate a miniaturized built-in charge-to-voltage converter. Low impedance types require an external power supply coupler to energize the electronics and decouple the subsequent DC bias voltage from the output signal.

Dynamic behavior of sensors

Piezoelectric sensors for measuring pressure, force and acceleration may be regarded as under-damped, spring mass systems with a single degree of freedom. They are modelled by the classical second order differential equation whose solution is:

$$\frac{a_o}{a_b} \cong \frac{1}{\sqrt{[1 - (\frac{f}{f_n})^2]^2 + (\frac{1}{Q})^2 (\frac{f}{f_n})^2}}$$

Where:

- f_n = undamped natural (resonant) frequency (Hz)
- f = frequency at any given point of the curve (Hz)
- a_o = output acceleration
- a_b = mounting base or reference acceleration ($f/f_n = 1$)
- Q = factor of amplitude increase at resonance

Quartz sensors have a Q of approximately 10 to 40 and therefore the phase angle can be written as:

$$\text{phase lag (deg)} \cong \frac{60}{Q} \left(\frac{f}{f_n} \right) \text{ for } \frac{f}{f_n} \leq \frac{2}{5}$$

A typical frequency response curve is shown in figure 3. As shown, about 5% amplitude rise can be expected at approximately 1/5 of the resonant frequency (f_n). Low-pass (LP) filtering can be used to attenuate the effects of this. Many Kistler signal conditioners (charge amplifiers and couplers) have plug-in filters for this purpose.

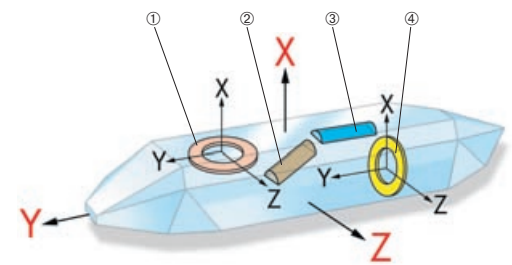

Figure 1
Quartz bar

- ① = compression cut
- ② = polystable cut
- ③ = transverse cut
- ④ = shear cut

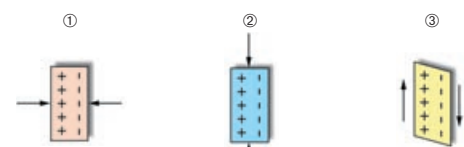

Figure 2
Piezoelectric effect

- ① = longitudinal effect
- ② = transverse effect
- ③ = shear effect

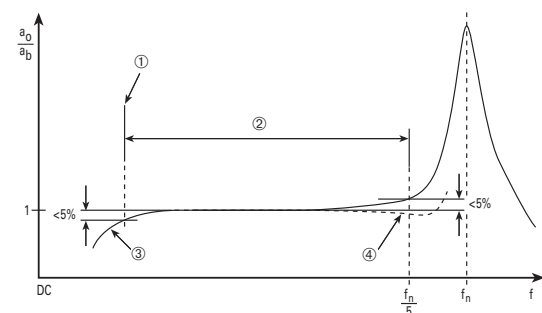

Figure 3
Typical frequency response curve

- ① = low frequency limit determined by RC roll-off characteristics
- ② = useable range
- ③ = HP filter roll-off characteristics
- ④ = with LP filter

Piezoelectric Theory

Charge amplifiers

Basically the charge amplifier consists of a high-gain inverting voltage amplifier with a MOSFET or J-FET at its input to achieve high insulation resistance. A simplified model of the charge amplifier is shown in figure 4.

The effects of R_i and R_j will be discussed below. Neglecting their effects, the resulting output voltage becomes:

$$V_o = \frac{-q}{C_r} \times \frac{1}{1 + \frac{1}{AC_r} (C_t + C_r + C_c)}$$

For sufficiently high open loop gain, the cable and sensor capacitance can be neglected and the output voltage depends only on the input charge and the range capacitance.

$$V_o = \frac{-q}{C_r}$$

In summary, the amplifier acts as a charge integrator which compensates the sensor's electrical charge with a charge of equal magnitude and opposite polarity and ultimately produces a voltage across the range capacitor. In effect, the purpose of the charge amplifier is to convert the high impedance charge input (q) into a useable output voltage (V_o).

Time constant and drift

Two of the more important considerations in the practical use of charge amplifiers are time constant and drift. The time constant is defined as the discharge time of an AC coupled circuit. In a period of time equivalent to one time constant, a step input will decay to 37% of its original value.

Time Constant (TC) of a charge amplifier is determined by the product of the range capacitor (C_r) and the time constant resistor (R_i):

$$TC = R_i C_r$$

Drift is defined as an undesirable change in output signal over time, which is not a function of the measured variable.

Drift in a charge amplifier can be caused by low insulation resistance at the input (R_i) or by leakage current of the input MOSFET or J-FET.

Drift and time constant simultaneously affect a charge amplifiers output. One or the other will be dominant. Either the charge amplifier output will drift towards saturation (power supply) at the drift rate or it will decay towards zero at the time constant rate.

Many Kistler charge amplifiers have selectable time constants which are altered by changing the time constant resistor (R_i). Several of these charge amplifiers have a "Short", "Medium" or "Long" time constant selection switch. In the "Long" position, drift dominates any time constant effect. As long as the input insulation resistance (R_i) is maintained at greater than 10^{13} ohms, the charge amplifier (with MOSFET input) will drift at an approximate rate of 0.03 pC/s. Charge amplifiers with J-FET inputs are available for industrial applications but have an increased drift rate of about 0.3 pC/s.

In the "Short" and "Medium" positions, the time constant effect dominates normal leakage drift. The actual value can be determined by referring to the appropriate operation/instruction manual which is supplied with the unit. Kistler charge amplifiers without "Short", "Medium" or "Long" time constant selection, operate in the "Long" mode and drift at the rates listed above. Some of these units can be internally modified for shorter time constants to eliminate the effects of drift.

Frequency and time domain considerations

When considering the effects of time constant, the user must think in terms of either frequency or time domain.

The longer the time constant, the better the low-end frequency response and the longer the useable measuring time. When measuring vibration, time constant has the same effect as a single-pole, high-pass (HP) filter whose amplitude and phase are:

$$\frac{V_o}{V_{in}} = \frac{2\pi f (TC)}{\sqrt{1 + [2\pi f (TC)]^2}}$$

$$\text{phase lead (deg)} = \arctan \frac{1}{2\pi f (TC)} \cong 80 \sqrt{\frac{V_{in} - V_o}{V_{in}}}$$

For example, the output voltage has declined approximately 5% when $f \times TC$ equals 0.5 and the phase lead is 18 degrees.

When measuring events with wide (or multiple) pulse widths. The time constant should be at least 100 times longer than the total event duration. Otherwise, the DC component of the output signal will decay towards zero before the event is completed.

Selection matrix

Other design features incorporated into Kistler charge amplifiers include range normalization for whole number output, low-pass filters for attenuating sensor resonant effects, electrical isolation for minimizing ground loops and digital/computer control of setup parameters.

Low impedance piezoelectric sensors

Piezoelectric sensors with miniature, built-in charge-to-voltage converters are identified as low impedance units throughout this catalogue. These units utilize the same types of piezoelectric sensing element(s) as their high impedance counterparts. Piezotron, Picotron, PiezoBeam, Ceramic Shear and K-Shear are all forms of Kistler low impedance sensors.

In 1966, Kistler developed the first commercially available piezoelectric sensor with internal circuitry. This internal circuit is a patented design called Piezotron. This circuitry employs a miniature MOSFET input stage followed by a bipolar transistor stage and operates as a source follower (unity gain). A monolithic integrated circuit is utilized which incorporates these circuit elements. This circuit has very high input impedance ($10^{14} \Omega$) and low output impedance (100Ω) which allows the charge generated by the quartz element to be converted into a useable voltage. The Piezotron design also has the great virtue of requiring only a single lead for power-in and signal-out. Power to the circuit is provided by a Kistler coupler (Power Supply), which supplies a source current (2–18 mA) and energizing voltage (20–30 VDC). Certain (extreme) combinations of other manufacturer's supply current and energizing voltage (i.e. 20 mA and 18 VDC, respectively), together with actual bias level, may restrict operating temperature range and voltage output swing. Call Kistler for details. Connection is as shown in figure 5. A Kistler coupler and cable is all that is needed to operate a Kistler low impedance sensor.

The steady state output voltage is essentially the input voltage at the MOSFET Gate plus any offset bias adjustment. The voltage sensitivity of a Piezotron unit can be approximated by:

$$V_o \cong \frac{q}{C_q + C_r + C_G}$$

The range capacitance (C_r) and time constant resistor (R_t) are designed to provide a predetermined sensitivity (mV/g) and upper and lower useable frequency. The exact sensitivity is measured during calibration and its value is recorded on each unit's calibration certificate.

Since its invention, the Piezotron design has been adapted by manufacturers worldwide and has become a widely used standard for design of sensors which measure acceleration, force and pressure. The concept has become known by many names besides Piezotron such as low impedance or voltage mode. Also, a number of "brand names" have emerged by other manufactures.

Picotron is a miniature accelerometer whose circuitry is very similar to the Piezotron. PiezoBeam incorporates a bimorph ceramic element and a miniature hybrid charge amplifier for the charge-to-voltage conversion. K-Shear is the newest member of the Kistler low impedance family and utilizes a shear quartz element together with the Piezotron circuitry.

Time constant

The time constant of a Piezotron or Picotron sensor is:

$$TC = R_t (C_q + C_r + C_G)$$

A PiezoBeam's time constant is the product of its hybrid charge amplifier's range capacitor and time constant resistor.

Time constant effects in low impedance sensors and in charge amplifiers are the same. That is, both act as a single pole, high-pass filter as discussed previously.

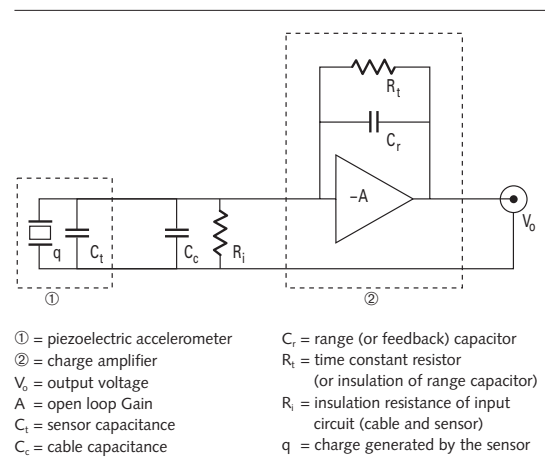

Figure 4
Simplified charge amplifier model

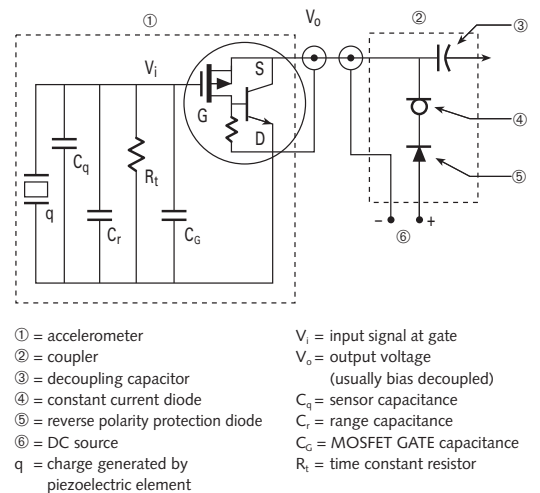

Figure 5
Piezotron
Circuit & coupler

Piezoelectric Theory

Low impedance power supply (coupler)

All of the low impedance types mentioned earlier require similar excitation for their built-in electronics. A single two-wire coaxial cable and a Kistler power supply coupler is all that is needed. Both the power into and the signal out from the sensor are transmitted over this two-wire cable. The coupler provides the constant current excitation required for linear operation over a wide voltage range and also decouples the bias voltage from the output.

Time constant

Bias decoupling methods can be categorized as AC or DC. DC methods of bias decoupling will not effect a low impedance sensor's time constant and therefore permit optimum low frequency response. An offset voltage adjust is used to "zero" the bias. AC decoupling methods, however, can shorten the low impedance sensor's time constant and degrade low frequency response. In low impedance systems, with AC bias decoupling, the system time constant can be approximated by taking the product of the sensor and coupler time constants and dividing by their sum. The resulting frequency response can be computed as before.

Selection matrix

Many other performance features are incorporated into Kistler's line of power supply couplers. Included are versions with multi-channel inputs, 100X gain, plug-in filters and computer controlled set-up parameters.

Dual mode charge amplifiers

Another method for powering low impedance sensors is to use a Dual Mode charge amplifier (high/low impedance). Dual mode units can be used as standard charge amplifiers with high impedance sensors or as couplers (with adjustable gain) for low impedance units.

High and low impedance system comparison

Similarities

Both systems utilize the same type of piezoelectric sensing element(s) and therefore are AC coupled systems with limited low frequency response or quasistatic measuring capability. Their respective time constants determine the useable frequency range.

High impedance systems

Usually high impedance systems are more versatile than low impedance. Time constant, gain, normalization and reset are all controlled via an external charge amplifier. In addition, the time constants are usually longer with high impedance systems allowing easy short-term static calibration. Because they contain no built-in electronics, they have a wider operating temperature range.

Low impedance systems

Generally, low impedance systems are tailored to a particular application. Since the low impedance sensor has an internally fixed range and time constant, it may limit use to their intended application. High impedance systems, with control of range and time constant via an external charge amplifier, have no such restriction.

However, for applications with well-defined measuring frequency and temperature ranges, low impedance (Piezotron) systems offer a potentially lower cost (i.e. charge amplifier vs. coupler cost) alternative to high impedance systems. In addition, low impedance sensors can be used with general purpose cables in environments where high humidity/contamination could be detrimental to the high insulation resistance required for high impedance sensors. Also, longer cable lengths, between sensor and signal conditioner and compatibility with a wide range of signal display devices are further advantages of low impedance sensors.

External impedance converters

An alternative method for processing charge from high impedance sensors is to use an external impedance converter. This method is often used to exploit the high temperature range of high impedance sensors while implementing the convenience and cost effectiveness of the coupler.

External impedance converters incorporate the same circuitry as the Piezotron. The only difference is that the sensor cable capacitance must be added to the sensor capacitance (C_q).

Sensor quality/calibration

Over the years, the Kistler name has become synonymous with QUALITY. We at Kistler are dedicated to continuous improvement in all areas; Design, Manufacturing, Quality Control, Quality Assurance and Calibration.

All Kistler products are manufactured in conformance with the requirements of ISO 9001: 2000 and MIL-I-45208A. Kistler's calibration system complies with the requirements of MIL-STD-45662A and ANSI/NCSL Z540. Calibrations performed at Kistler are traceable to NIST, or the Swiss Federal Office of Metrology. Calibration laboratories are accredited to ISO/IEC 17025. Kistler takes full advantage of the latest technology, performing computer controlled testing, calibration and data collection. Kistler products are used as primary standards for many of the world's leading test and national calibration laboratory facilities, including NIST.

Kistler calibration techniques

Force sensors

The calibration of force sensors is very similar to pressure sensors. The unit under test is calibrated against a standard force ring whose calibration is traceable to NIST. A hydraulic press is used to generate forces for this calibration.

Accelerometers

Kistler acceleration standards are periodically calibrated by an independent third party providing NIST traceability. These primary standards are used to calibrate a set of working standards at Kistler. The working standards are configured to accept direct mounting of the unit under test. "Back to Back" calibration technique minimizes errors. Calibration is performed on a sinusoidal motion shaker.

Glossary and technical references

A glossary of technical terms used throughout this catalogue follows this section. Also, refer to the inside back cover for a comprehensive list of Kistler technical articles that have been compiled over the years by authorities in the field of piezoelectric instrumentation.



Capacitive Accelerometer Theory

The fundamental principle of operation for a capacitive accelerometer is the property that a repeatable change in capacitance exists when a sensing structure is deflected due to an imposed acceleration.

The acceleration creates a force (F) acting on a suspended flexure of known mass (m). The flexure moves predictably and in a controlled manner dictated by its stiffness (k). A gas filled gap (d) exists between surrounding electrodes as shown in figure 1. The inertial force can be calculated from Newton's Second Law of Motion as:

$$F = m a \quad [\text{Eq. 1}]$$

Knowing the force, a displacement of the flexure can be estimated using a simple spring calculation:

$$x = F/k \quad [\text{Eq. 2}]$$

However, in practice, Finite Element Analysis (FEA) is employed to model the complicated spring designs. This displacement alters the gaps on either side of the flexure in an equal but opposite proportion. The distance between the flexure and surrounding electrodes (l), is then the nominal [zero g] spacing (d) ± the spring deflection (x) or:

$$l_1 = d + x \quad \& \quad l_2 = d - x \quad [\text{Eq. 3}]$$

Knowing the electrode area (A) and the permittivity constant of the gas (E), the capacitance formed by the gaps can be determined from:

$$C_1 = A \epsilon / l_1 \quad \& \quad C_2 = A \epsilon / l_2 \quad [\text{Eq. 4}]$$

This capacitance difference causes an imbalance in a bridge network of the internal electronic circuit. Internal signal conditioning incorporates AC excitation and synchronous demodulation. In addition, it provides power for the accelerometer element and outputs an analogue voltage proportional to the acceleration signal.

The key operating principle of figure 2 is that a variable capacitive element unbalances a bridge relative to applied acceleration. The electronic action is summarized as follows:

- A voltage regulator stabilizes the accelerometer sensitivity and assures internal functions remain constant despite the supply voltage level
- A square wave generator produces excitation for the bridge circuit
- A capacitive bridge produces two signals with amplitudes relative to the applied acceleration
- Diodes rectify and produce two opposing DC signals
- The opposing signals are summed to form the representative output
- A preamplifier provides gain
- A built-in low pass filter attenuates unwanted signals above the operating frequency range

Kistler micromachined K-Beam accelerometer sensing elements consist of very small inertial mass and flexure elements chemically etched from a single piece of silicon. The seismic mass is supported by flexure elements between two plates, which act as electrodes. As the mass deflects under acceleration, the capacitance between these plates changes. Under very large accelerations (or shocks), the motion of the mass is limited by the two stationary plates thereby limiting the stress placed on the suspension and preventing damage. The typical design is shown in figure 3.

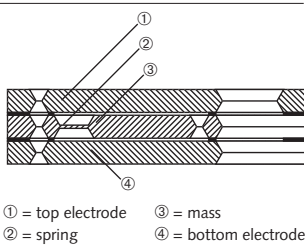

Figure 1
Typical capacitive accelerometer arrangement

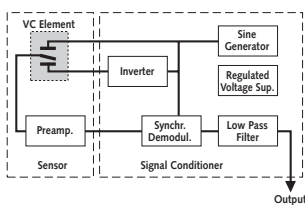

Figure 2
Electrical schematic

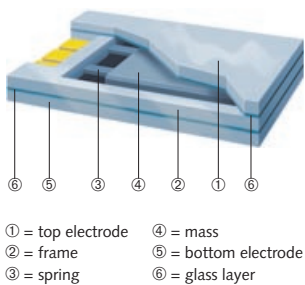

Figure 3
MEMS variable capacitance accelerometer

The damping of the mass by an entrapped gas creates a "squeeze film" providing an optimized frequency response over a wide temperature range. Additionally, its differential capacitive design assures immunity to thermal transients. The effort of damping is shown in figure 4a and appropriate damping is tuned with a specific spring mass system to achieve optimal frequency response (figure 4b).

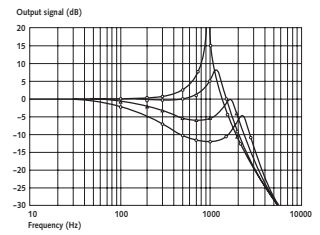

Figure 4a
Effect of damping

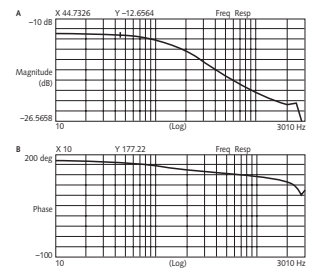

Figure 4b
Tuned system



Glossary

Bias voltage

DC (no load or quiescent) output level of a low impedance sensor powered by constant current excitation.

Ceramic Shear

Kistler piezoelectric accelerometer family which utilizes ceramic shear sensing elements.

Charge amplifier

Electronic unit which utilizes a high-gain voltage amplifier with negative, capacitive feedback for converting a charge from a piezoelectric sensor into a low impedance output voltage.

Charge output

Output in Pico Coulombs (pC) from a piezoelectric sensor without a built-in charge-to-voltage converter (see High impedance).

Circuit integrity indication

A quick-look reference on couplers or dual mode charge amplifier for identifying whether a low impedance system has the proper bias voltage. Analogue meters and multi-color LEDs are the most commonly used indicators.

Constant current excitation

Method of powering low impedance sensors to insure minimal sensitivity variation over a wide voltage range. A piezotron coupler or any other ICP type power supply may be used for this purpose.

Coupler

Electronic unit which supplies constant current excitation to low impedance sensors and decouples the subsequent bias voltage.

Cross talk

Another term for cross axis or transverse sensitivity; used on Kistler multi-component force sensors to describe the output on one axis caused by inputs on the others.

Drift

An undesirable change in output signal, over time, which is not a function of the measurand.

Dual mode

Refers to a charge amplifier which can be used either with high impedance, charge output or with low impedance, voltage output sensors.

Ground isolation

The electrical resistance between the signal return/common and mounting ground of a sensor, or between an electrical connector shield and power ground of a charge amplifier/coupler.

High impedance

Another term for a piezoelectric sensor with charge output (i.e. pC/mechanical unit).

Hysteresis

The maximum difference in output, at any measured value within the specified range when the value is approached first with increasing and then decreasing measurand.

Impedance converter

A miniature electronic unit with MOSFET input and bipolar output for converting high impedance, charge outputs (from a sensor) into low impedance, voltage outputs. Impedance converters can be built into the sensor (see Low impedance) or can be used externally for special applications.

Impedance head

Sensor that simultaneously measures both force and acceleration during modal analysis testing.

Insulation resistance

The resistance of a high impedance sensor, cable or charge amplifier measured between the signal lead and connector ground.

K-Beam®

Kistler's solid-state, variable capacitance based line of accelerometers, which are suitable for measuring low frequencies or even steady-state conditions.

K-Shear®

Kistler's piezoelectric accelerometer family. Low impedance accelerometer, which utilizes quartz shear sensing element.

Linearity

The closeness of a calibration curve to a specified straight line. Kistler uses "Best straight line through zero" which is defined as follows: two parallels are sought, as close together as possible but enclosing the entire calibration curve. In addition, the median parallel must pass through zero (no measurand, no output signal). The slope of this median parallel is the sensitivity of the sensor. Half the interval between the two parallels, expressed as a percentage of Full-Scale Output (FSO), is the linearity.

Low impedance

Another name for a piezoelectric sensor with a miniature, built-in charge to voltage converter. Output is typically in mV/mechanical unit. K-Shear, Piezotron, Picotron and PiezoBeam are all forms of low impedance sensors.

Low pass filter

An electronic network for passing low and attenuating high frequencies. Many plug-in types are available for Kistler charge amplifiers and power supply/couplers.

Measurand

A physical quantity, property or condition which is measured (i.e. pressure, force or acceleration).

MEMS

Micro Electro Mechanical Sensor

Multi-Component force sensor

Kistler design utilizing compressive and shear quartz elements for measuring up to three force components and three moments.

Natural frequency

The frequency of free (not forced) oscillations of the sensing element of a fully assembled sensor.

Pico Coulomb (pC)

A unit of electrical charge equivalent to 1×10^{-12} amps.

Picotron

Miniature accelerometer with Piezotron circuitry.

PiezoBeam®

Low impedance accelerometer. Incorporates a bimorph ceramic element charge when mechanically loaded.

Piezoelectric sensor

Sensor with a sensing element that generates an electrical charge when mechanically loaded.

Piezotron®

Patented Kistler piezoelectric sensors with miniature, built-in impedance converters (see Impedance converter).

Polystable®

Patented Kistler quartz element incorporated into pressure sensor designs for operating temperatures up to 350 °C.

Quasistatic

Term which denotes Kistler's ability to make short-term static or near DC measurements with high impedance sensors and charge amplifiers.

Resonant frequency

The measurand frequency at which a sensor responds with maximum output amplitude.

Rise time

The length of time for the output of a sensor to rise from 10% to 90% of its final value as a result of a step-change of measurand.

Sensitivity

The ratio of the change in sensor output to a change in the value of the measurand. Expressed in pC or mV per mechanical unit.

TEDS

Transducer Electronic Data Sheet. Characteristic data stored digitally internal to sensor, IEEE 1451.4 compliant.

Temperature coefficient of sensitivity

The change in sensitivity of a sensor at different (constant) operating temperatures. Typically expressed as a percent change per unit temperature change (%/°C).

Time constant

(TC) Refers to the discharge time of an AC coupled circuit. In the time domain, a DC signal will decay to 37% of its original value in a period of time equivalent to one time constant.

In high impedance systems, the time constant is the product of the charge amplifier's range capacitor and time constant resistor. In low impedance systems, the system time constant can be approximated by taking the product of sensor and coupler time constants and dividing by their sum.

In frequency domain, time constant can be related to a high pass filter network with a low frequency cutoff (-5% pt.) equal to $0.5/TC$.

Threshold

The smallest change in the measurand that will result in a measurable change in sensor output.

For charge output sensors, threshold denotes the equivalent noise level in a standard charge amplifier. For voltage output sensors, threshold denotes the equivalent noise level of its built-in charge to voltage converter.

Transverse sensitivity

The output of an accelerometer caused by acceleration perpendicular to the measuring axis.

Voltage output

Output from a piezoelectric sensor with a built-in charge-to-voltage converter (see Low impedance).

Kistler – Customer Service

Kistler offers a comprehensive range of services:

Technical advice

Experienced specialists from every area of application are at the disposal of our customers. Kistler consultancy services include the identification and definition of each individual measurement task, the development of the solution, the selection of the appropriate measuring system and the planning of the installation.



Test equipment

Kistler provides its customers with proper equipment to help solve specific application problems.

Repair service

In the event of the failure of a measuring chain, Kistler specialists help to keep downtime of machinery or production lines to a minimum.

Calibration

Kistler offers a calibration service for the periodic testing of measuring accuracy in accordance with ISO 17025. If necessary, this service can be performed on site. Kistler keeps a comprehensive record to show which sensors have been calibrated, as well as when and how. Kistler also has a whole series of instruments for equipping calibration laboratories.

Information

In order to keep customers constantly aware of the latest information, Kistler passes on its specialist knowledge at exhibitions, trade fairs, conferences, symposiums and seminars. Information in the form of data sheets, brochures, reprints, operating instructions and application descriptions is also available to our customers in printed or electronic form.

Training

Kistler trains its engineers thoroughly at its own training center so that their knowledge corresponds to the latest state of the art. Kistler also holds regular seminars for customers on special subject areas.

You can count on the support of experienced specialists.



A highly effective repair service minimizes downtime.



A calibration service periodically checks measuring accuracy.



Many Kistler products are available from stock.



Kistler engineers are always abreast of the latest developments.



The Kistler Spectrum

With around 5000 products,
Kistler covers a broad
spectrum.

Acceleration

In addition to the field of acceleration
measurement covered in this brochure,
Kistler is involved in three other
product areas:



Force

Kistler sensors have been used for almost 50 years for dynamic and quasi-static measurements ranging from very small to very large forces. Kistler force sensors have proved their worth wherever precise results are needed and however extreme the conditions.

Pressure

Kistler sensors can be used to measure almost any pressure – from the gas pressure in internal combustion engines to the pressure in a plastic melt or a pressure drop in dialysis equipment. They also serve to supply precise process information under extreme conditions.

Measurement and analysis

Kistler technology serves to measure minute variations in pressure, force or acceleration, even under extreme conditions, and to display them on high-precision electronic instruments. Kistler also supplies the hardware and software needed to convert the raw data for measurement related process control.

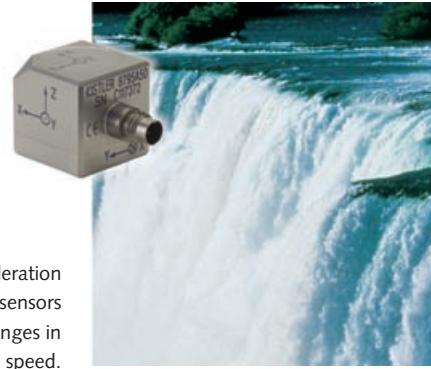

In the acceleration field, Kistler sensors measure changes in speed.



Kistler sensors measure force, torque and strain.



Kistler sensors can be used to measure almost any pressure.



Kistler supplies hardware and software for measurement related open-loop and closed-loop process control.



Kistler Applications

Kistler sensors are used
in applications of all kinds.



Engines

Kistler measuring technology helps engineers to optimize the operation of internal combustion engines, combining maximum efficiency with minimum exhaust pollution.

Vehicles

Kistler sensors help to make automobiles safer and more comfortable and reduce the cost of road maintenance. They serve to measure forces of all kinds in the vehicle suspension, bodywork, and wheels, as well as the road surface.

Manufacturing

To maintain the quality and reduce the costs of mass production, the manufacturing processes must first be determined and optimized in a series of tests and subsequently kept under constant monitoring. Kistler supplies the measuring technology for both applications.

Instruments and equipment

Kistler pressure, force and acceleration sensors are to be found in any number of machines and electrical equipment for industrial applications. They support open-loop and closed-loop control of a wide variety of processes.

Plastics processing

Kistler pressure sensors and control technology make it possible to increase process quality in the manufacture of plastic components. Constant manufacturing quality reduces scrap and start-up losses and increases profitability.

Biomechanics

Through high precision measurement of human gait, Kistler force plates help athletes to optimize their performance and physicians to understand the locomotor system and reduce stresses.

Acceleration

A wide variety of accelerometers are offered to accommodate even the most demanding measurements. Miniature types provide minimal mass loading yet provide significant signal for analysis. High sensitivity types are available for testing of low amplitude motions down to steady state, DC. Our accelerometers have been optimized for the most common applications and custom solutions are readily available.

Internal combustion engines become more economical and environmentally friendly.



Cars become safer and more comfortable.



Mass production becomes more cost effective.



Industrial processes are precisely controlled and regulated.



Process quality in the manufacture of plastic components is improved.



Kistler force plates optimize performance in many sports.



Ride quality of mass transit systems is optimized when tilt and sway are accurately measured and controlled.



Kistler in Brief



measure.



analyze.



innovate.

Kistler enjoys a worldwide reputation as a leading supplier of measurement technology. Kistler sensors use the piezoelectric effect, piezoresistive or capacitive, to measure pressure, force and acceleration.

Our aim

The top priority at Kistler is to satisfy the needs and requirements of our customers. This includes developing leading-edge products and helping our customers to obtain optimum results from their application.

Our philosophy

Our success is based on innovative technologies, precise knowledge of our markets and a comprehensive range of services.

measure. analyze. innovate.

measure.

Our core strength is the use of sensors to measure physical changes.

analyze.

The physical changes measured have no intrinsic significance by themselves. It is only through analysis and evaluation of the measurements that a process can be understood. To this end, we supply our customers with all the necessary hardware and software to analyze these changes.

innovate.

The information obtained in this way constitutes the basis for innovative products and serves to open up new horizons.

Successful research

Over the years, Kistler's heavy investment in research and development has generated a number of revolutionary innovations:

- the world's first commercial quartz sensor
- the patented two-wire constant current technology constituting the basis for today's sensors with integrated microelectronic circuitry
- the first high-temperature pressure sensors up to 350 °C, polystable quartz cut
- the first three-component force measuring sensors
- own crystal growth capabilities for special high sensitivity and high temperature crystals.

These innovations resulted in solutions to numerous measuring problems for the first time.

Comprehensive services

Kistler also supplies a comprehensive range of services, including technical advice for all applications, calibration and repair services, as well as regular training.

Kistler today

Established in Winterthur (Switzerland) in 1959, Kistler currently employs 650 staff worldwide, around 15% of whom are engaged in research and development.

In addition to its headquarters at Winterthur, Kistler is represented in over 50 countries and has group companies in the USA, Germany, Austria, Denmark, Finland, France, Italy, the Netherlands, Norway, Sweden, the United Kingdom, Japan, the People's Republic of China, India, Korea, Singapore and Taiwan.



Our History

1957

Kistler Instruments established in Winterthur, Switzerland.

1958

First miniature quartz pressure sensor, a device which is to set the standard in pressure measuring technology.

1962

Kistler Instrument Corp. moves to its own facilities in Clarence, NY.

1963

Establishment of the German group company near Stuttgart.

1965

Kistler introduces the world's first quartz force sensor.

1966

Kistler moves into its new company building in Winterthur/Wülflingen.

1967

First charge amplifier with MOS-FET.

1968

Kistler introduces another world innovation, three-component force sensors, capable of measuring all three components of a force and their exact direction.

1973

Kistler launches sensors based on the piezoresistive technology.

1974

Introduction of quartz sensors for temperatures above 350 °C.

1979

Kistler Instrument Corp. expands and moves to Buffalo, NY.

1980

Introduction of the world's first quartz strain sensor, an instrument which, even today, offers unrivalled sensitivity.

1983

Introduction of Kistler's unique quartz wheel force dynamometer.

1986

Establishment of the Japanese group company in Tokyo.

1987

Introduced first Piezo Beam® - low impedance accelerometer that incorporates a bimorph ceramic element and hybrid charge amp for ultra-high sensitivity in a small, rugged package

1989

Another world first from Kistler – a high-temperature sensor with a diameter of only 5 mm for use in engine measuring technology.

1991

Kistler becomes an accredited calibration station ("SCS 049") for pressure, force, acceleration and electric charge.

1992

Introduced first K-Beam® - solid-state, variable capacitance based line of accelerometers for measuring low frequency or steady-state conditions.

1997

Certified according to ISO 9001

Introduced Ceramic Shear piezoelectric accelerometer which utilizes ceramic shear sensing elements.

2000

Major expansion of the production plant in Winterthur.

2002

Introduced ServoK-Beam® - solid-state, variable capacitance based line of accelerometers designed to replace traditional servo accelerometers due to the exceptional performance, small size and inexpensive cost.

2004

Achieved ISO/IEC 17025 Accreditation.

First PiezoSmart sensors for combustion engine measurements.

Research efforts focused on one objective: ultra-modern, customer-oriented solutions.



Kistler solutions are developed in close cooperation with the user.



A world first: Kistler quartz sensors.



Kistler is represented in over 50 countries worldwide.



Kistler Instrumente AG, Winterthur, Switzerland



Kistler Instrument Corp., Amherst, NY



Kistler today

Today, Kistler Instrumente AG ranks with over 650 employees as a world leader in the measuring technology market. 17 group companies and over 40 distributors guarantee a close contact to the customer.

Technical Literature

Technical publications and application brochures *

Acceleration					
PiezoBeam accelerometers: reliable design for modal analysis	20.148	Energy transfer during impact testing	K20.230	K-Beam capacitive accelerometers	54.203*
Measuring simultaneously translational and angular acceleration with the new TAP system	20.149	A case for low impedance	K20.240	High temperature accelerometers	54.205*
Lightweight capacitive accelerometers for low frequency measurements	20.159	The Piezotron concept as a practical approach to vibration measurement	K20.250	Shear mode quartz shock sensor	920-248
A consideration of the effects of local rotations on the output of various accelerometer designs	20.167	A comparison of angular acceleration and translation acceleration measurements on a free-free beam	K20.270	Force	
New acoustic emission sensors for in-process monitoring	20.171	Shear mode quartz shock sensor	20.300	Piezoelectric sensors for the combined measurement of forces and acoustic emission for in-process monitoring	20.170
K-Beam capacitive accelerometers – for static response	20.179	IEEE P1451.4: Measurement with smart transducers	20.302	Theory	
K-Shear accelerometers	20.184	A novel Annular Shear piezoceramic accelerometer with central preload and optimized volumetric efficiency	20.304	Piezoelectric measuring instruments and their applications	20.116
Basic theory of the hammer test method	20.195	Force limited vibration tests	K20.310	Frequency response of piezoelectric transducers	K20.260
		Structural testing-modal analysis	54.202*		



Product Index

Type	Page	Type	Page	Type	Page
557	65	8290A...	45	8734A...	36
558	65	8305A...	23	8742A...	37
1511	72	8310A...	23/24	8743A...	38
1576	72	8312A...	25	8752A...	38
1592A	72	8330A...	25	8762A...	47
1601B	72	8393A...	45	8763A...	48
1603B	72	8402	70	8765A...	49
1631C	72	8404	70	8770A...	55
1635C	73	8410	70	8772A...	39
1641	73	8411	70	8774A...	39
1756B	73	8412	71	8776A...	39/40
1761B	73	8414	71	8778A...	40
1762B	73	8416	70	8784A...	41
1770A	73	8418	70	8786A...	41
1772A	74	8420	71	8791A...	49
1776A	74	8421	71	8792A...	50
1778A	74	8434	69	8793A...	51
1784AK02	74	8436	69	8794A...	51
1784AK03	74	8438	69	8795A...	52
1786C	75	8439	69	8802	79
1788A	75	8440	69	8804	79
1790A2	75	8450	69	8810	67
1794A	75	8452	69	8838	41
5000M04	76	8456	69	8840	41
5015A	61	8458	70	8921	79
5050A...	61	8474	71	9222	55
5108A	62	8476	71	9712B...	56
5110	62	8516	71	9722A...	57
5114	63	8518	71	9724A...	57
5118B...	63	8530	71	9726A...	58
5125B...	64	8614A...	30	9728A...	58
5127B...	64	8632C...	31		
5134A1	64	8636C...	31		
5148	65	8676K	32		
5210	66	8690C...	46		
5493	66	8692C...	46		
8002...	27	8694...	47		
8002K...	80	8702B...	32/33		
8044	27	8704B...	32/33		
8076K	80	8704B5000	33		
8141	30	8710A...	34		
8152B...	43	8712A...	34		
8202A...	28	8720A...	35		
8203A...	28	8728A...	35		
8274A...	29	8730A...	36		
8276A...	29	8732A...	36		

K-Beam®, K-Guard®, K-Shear®, PiezoBeam®, PiezoStar®, Piezotron® and Polystable® are registered trademarks of Kistler Instrumente AG, Winterthur, Switzerland
Kistler is a registered trademark of Kistler Holding, Winterthur, Switzerland

Kistler worldwide

Europe

Germany

Kistler Instrumente GmbH
Daimlerstrasse 6
DE-73760 Ostfildern
Tel. +49 711 34 07 0
Fax +49 711 34 07 159
info.de@kistler.com

France

Kistler France
ZA de Courtabœuf 1
15, avenue du Hoggar
FR-91953 Les Ulis cedex
Tel. +33 1 69 18 81 81
Fax +33 1 69 18 81 89
info.fr@kistler.com

Switzerland/Liechtenstein

Kistler Instrumente AG
Verkauf Schweiz
Eulachstrasse 22
CH-8408 Winterthur
Tel. +41 52 224 12 32
Fax +41 52 224 14 21
sales.ch@kistler.com

Austria

Kistler GmbH
Lemböckgasse 49f
AT-1230 Wien
Tel. +43 1 867 48 67 0
Fax +43 1 867 48 67 17
sales.at@kistler.com

Italy

Kistler Italia s.r.l.
Via Ruggero di Lauria, 12/B
IT-20149 Milano
Tel. +39 02 481 27 51
Fax +39 02 481 28 21
sales.it@kistler.com

United Kingdom

Kistler Instruments Ltd.
Alresford House, Mill Lane
Alton, Hampshire GU34 2QJ
Tel. +44 1420 54 44 77
Fax +44 1420 54 44 74
sales.uk@kistler.com

Denmark/Finland/Norway/Sweden

Kistler Nordic AB
Aminogatan 34
SE-431 53 Mölndal
Tel. +46 31 871 566
Fax +46 31 871 597
info.se@kistler.com

Netherlands

Kistler B.V. Nederland
Leeghwaterstraat 25
NL-2811 DT Reeuwijk
Tel. +31 182 304 444
Fax +31 182 304 777
sales.nl@kistler.com

Asia

Japan

Kistler Japan Co., Ltd.
MT Building
2-7-5, Shibadaiimon
Minato-ku, Tokyo 105-0012
Tel. +81 3 35 78 02 71
Fax +81 3 35 78 02 78
sales.jp@kistler.com

China, People's Republic of

Kistler China Ltd.
Unit D, 24 / F Seabright Plaza
9-23 Shell Street
North Point, Hong Kong
Tel. +852 25 91 59 30
Fax +852 25 91 18 85
sales.cn@kistler.com

Representative Office Beijing

Tel. +86 10 8225 2163
Fax +86 10 8225 2124
sales.cn@kistler.com

India

Kistler Instruments (Pte) Ltd.
India Liaison Office
2B Century Plaza
560/562 Anna Salai
Teynampet, Chennai 600 018
Tel. +91 44 5213 2089
Fax +91 44 5213 2331
sales.in@kistler.com

Korea, Republic of

Kistler Korea Co., Ltd.
3rd Floor, Bow Building
1580-1, Seocho-3 dong,
Seocho-ku,
Seoul 137-875
Tel. +82 2 597 6013
Fax +82 2 525 6015
sales.kr@kistler.com

Singapore

Kistler Instruments (Pte) Ltd.
50 Bukit Batok Street 23
#04-06 Midview Building
Singapore 659578
Tel. +65 6316 7331
Fax +65 6316 7332
sales.sg@kistler.com

Taiwan

Kistler Representative Office in Taiwan
Room 9, 8F, No. 6, Lane 180
Sec. 6, Mincyuan E. Road
Taipei 114
Tel. +886 2 7721 2121
Fax +886 2 7721 2112
sales.tw@kistler.com

America

USA / Canada / Mexico

Kistler Instrument Corp.
75 John Glenn Drive
Amherst, NY 14228-2171
Tel. +1 716 691 5100
Fax +1 716 691 5226
sales.us@kistler.com

Other countries

Kistler Instrumente AG
Export Sales
Eulachstrasse 22
CH-8408 Winterthur
Tel. +41 52 224 11 11
Fax +41 52 224 15 49
sales.export@kistler.com

Headquarters

Switzerland

Kistler Instrumente AG
Eulachstrasse 22
CH-8408 Winterthur
Tel. +41 52 224 11 11
Fax +41 52 224 14 14
info@kistler.com

www.kistler.com

KISTLER
measure. analyze. innovate.